



6760

PARAMETRIC EQUALIZER

ASSEMBLY
&
USING

MANUAL



PAiA Electronics, Inc.

6760
MASTER PARTS LIST

8	10 ohm resistor	brown-black-black	
8	470 ohm resistor	yellow-violet-brown	
8	1000 ohm resistor	brown-black-red	
4	22K resistor	red-red-orange	
32	100K resistor	brown-black-yellow	
4	100 pf ceramic capacitors		(100K)
8	.01 mfd polyester capacitors		(103)
4	.22 mfd polyester capacitors		(224)
4	5 (4.7) mfd electrolytic caps		
8	10 mfd electrolytic caps		
4	100K potentiometers		
4	500K potentiometers		
4	dual ganged 100K pot.		
4	4136 type quad op amp IC's		
4	14 pin IC sockets		
8	mono 1/4" open-circuit phone jack		
2	"L" brackets		
4	4-40 X 1/4" machine screws		
4	#4 internal star lockwashers		
2	#4 hex machine nuts		
4	44" lengths stranded insulated wire		
30"	bare wire		
84"	RG 174U co-axial cable		
12	set-screw knobs		
1	circuit board		
1	front panel		

6760
ASSEMBLY INSTRUCTIONS

SOLDERING

Successful operation of your kit, as well as its longevity, is probably more dependent on how the components are soldered in place than any other one thing that the assembly involves. There are three key rules to go by, these are as follows:

TYPE OF SOLDER: Use ONLY ROSIN CORE SOLDER. Acid core solder or paste flux should never be used to assemble electronic circuitry, and the use of either on this kit will **VOID THE WARRANTY**. Good 60/40 rosin core solder is expensive, but it may be considered a long term investment, and well worth it!

SOLDERING TOOL: Use a soldering iron with a power rating of about 25 watts to 35 watts, and a small pointed tip. Soldering guns are completely unacceptable for soldering solid state components, as the large magnetic fields they generate can easily damage some components.

Be sure to keep your soldering iron tip clean. Before soldering a connection, wipe the tip on a damp sponge. This will aid in heat transfer and prolong tip life.

SOLDERING TECHNIQUE: We recommend looking at the solder connections on commercially available amps and effects units and try to imitate them as closely as possible. A proper circuit board solder joint has just enough solder to cover the soldering pad and about 1/16" (2mm) of the component lead passing through it.

To solder, hold the tip of the iron against both the wire to be soldered and the circuit board trace (or jack lug, switch lug, or whatever). Hold it there for a second or so to let things heat up, then feed a small amount of solder onto the connection. Do not simply feed the solder onto the tip of the iron and expect it to run down onto the connection. Continue holding the iron against the connection until the solder melts fully and flows freely over the connection. Then remove the iron and let the joint cool. Do not move any of the wires while the joint is cooling; if this happens, re-heat the connection, feeding in a tiny bit more solder.

There are two types of improper connections to watch out for; using too little solder (or too little heat) will result in a connection which will appear to be soldered when actually there is a layer of flux or oxidation insulating the component lead. To cure this, re-heat the connection and flow a small additional amount of solder onto the joint.

Using too much solder can lead to excess solder flowing between adjacent terminals or traces of a circuit board, causing a short circuit. Unintentional solder bridges of this type can be cleaned off onto the tip of a CLEAN, hot soldering iron while holding the board upside down. Another problem with using too much solder is that it can flow over to an adjacent hole, blocking it with solder. If this happens, again hold the board upside down and flow solder away from the hole and onto the tip of a clean hot iron. Use a pin to poke through any remaining solder left in the hole.

Finally, avoid using too much heat or leaving the iron on a connection for too long. Excessive heat can damage many types of electronic parts, and in extreme cases can cause circuit traces to lift from the circuit board. The exception to this rule is when soldering a wire to the lug of a switch, jack, potentiometer, etc., you should allow the heat to build up for a moment longer before applying the solder.

CIRCUIT BOARD ASSEMBLY

WIRE JUMPER INSTALLATION

- () Using the BARE wire provided, form and install the 16 wire jumpers on the circuit board. Designations for the jumpers are the solid lines broken by the letter "J" printed on the component side of the board and in the parts placement drawing. NOTE the wire supplied can be staightened by pulling it between your pinched thumb and forefinger several times. MAKE SURE THAT 16 WIRE JUMPERS ARE INSTALLED.

Figure 1: 6760 Parametric Equalizer parts placement

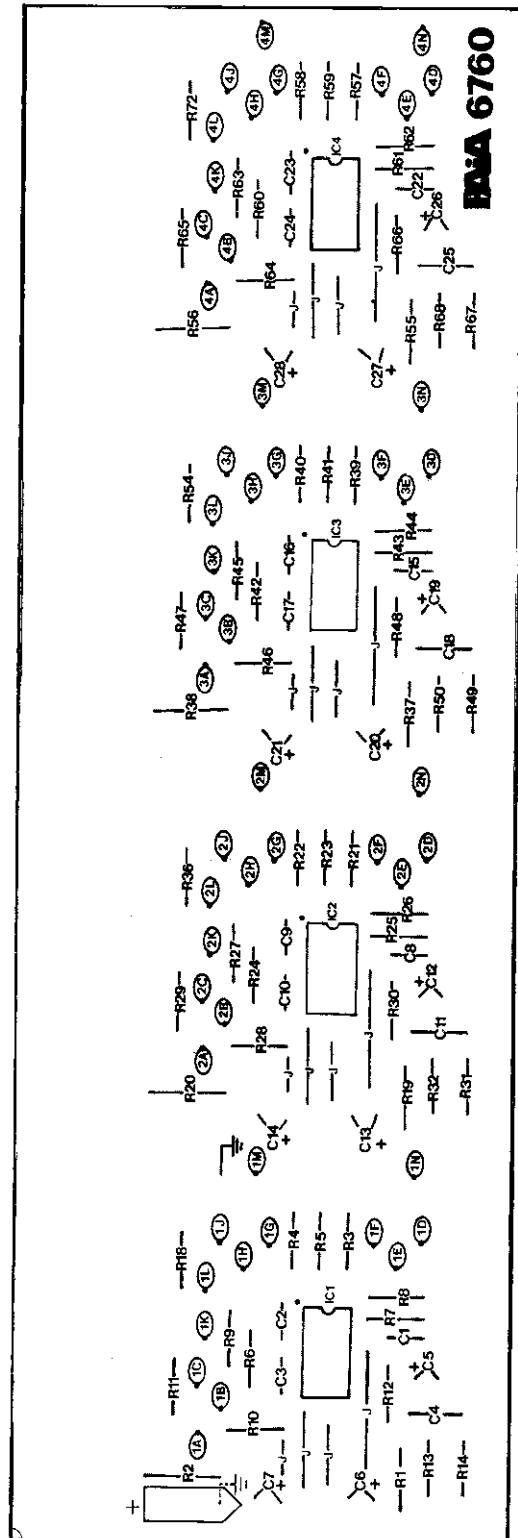

RESISTOR INSTALLATION

Solder each of the fixed resistors in place following the parts placement designators printed on the circuit board and shown in figure 1. Note that the fixed resistors are non-polarized and may be mounted with either of their leads in either of the holes provided. Insert both leads in the mounting holes and push the resistor fully against the board. On the conductor side of the board, bend the leads outward to about a 45 degree angle to help hold the component in place while soldering. AFTER SOLDERING, clip off each lead flush with the top of the solder joint.

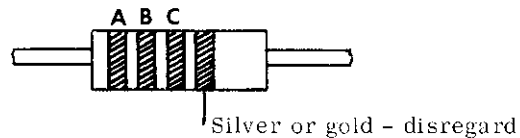

DESIGNATION	VALUE	COLOR CODE		
		A	B	C
() R1	10 ohms	brown	black	black
() R2	10 ohms	brown	black	black
() R19	10 ohms	brown	black	black
() R20	10 ohms	brown	black	black
() R37	10 ohms	brown	black	black
() R38	10 ohms	brown	black	black
() R55	10 ohms	brown	black	black
() R56	10 ohms	brown	black	black
() R3	470 ohms	yellow	violet	brown
() R4	470 ohms	yellow	violet	brown
() R21	470 ohms	yellow	violet	brown
() R22	470 ohms	yellow	violet	brown
() R39	470 ohms	yellow	violet	brown
() R40	470 ohms	yellow	violet	brown
() R57	470 ohms	yellow	violet	brown
() R58	470 ohms	yellow	violet	brown
() R5	1000 ohms	brown	black	red
() R6	1000 ohms	brown	black	red
() R23	1000 ohms	brown	black	red
() R24	1000 ohms	brown	black	red
() R41	1000 ohms	brown	black	red
() R42	1000 ohms	brown	black	red
() R59	1000 ohms	brown	black	red
() R60	1000 ohms	brown	black	red

- () R7 100K
- () R8 100K
- () R9 100K
- () R10 100K
- () R11 100K
- () R12 100K
- () R13 100K
- () R14 100K
- () R25 100K
- () R26 100K
- () R27 100K
- () R28 100K
- () R29 100K
- () R30 100K
- () R31 100K
- () R32 100K
- () R43 100K
- () R44 100K
- () R45 100K
- () R46 100K
- () R47 100K
- () R48 100K
- () R49 100K
- () R50 100K
- () R61 100K
- () R62 100K
- () R63 100K
- () R64 100K
- () R65 100K
- () R66 100K
- () R67 100K
- () R68 100K

A B C
brown-black-yellow



- () R18 22K
- () R36 22K
- () R54 22K
- () R72 22K

A B C
red-red-orange

IC SOCKET INSTALLATION

Install the 4 IC sockets by inserting their pins into the holes provided from the COMPONENT side of the circuit board and then soldering each pin to its respective pad on the CONDUCTOR side of the board. BE SURE THAT THE SOCKET IS PRESSED DOWN FIRMLY ON THE BOARD AND THAT ALL THE PINS ARE PROTRUDING THROUGH TO THE CONDUCTOR SIDE. Some sockets may bear orientation markings on one end. While there is no electrical significance to the orientation of the socket, it is good practice to acknowledge these marks and orient the socket accordingly. Normally the marked end will correspond to the semi-circle notch at one end of the parts placement designators for each IC.

- () Install the four 14 pin IC sockets.

IC socket

NOTE KEY

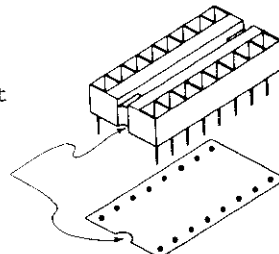

Install the ceramic disk capacitors. Like the resistors, these components are non-polarized. The value of the capacitor will be marked on the body of the part. Solder in place and clip the excess leads

DESIGNATION	VALUE	ALTERNATE MARKINGS
() C1	100 pf	100K
() C8	100 pf	
() C15	100 pf	
() C22	100 pf	

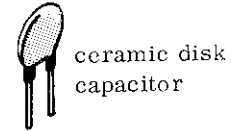

In the same manner, install the polyester capacitors.

DESIGNATION	VALUE	ALTERNATE MARKINGS
() C2	.01 mfd	103
() C3	.01 mfd	
() C9	.01 mfd	
() C10	.01 mfd	
() C16	.01 mfd	
() C17	.01 mfd	
() C23	.01 mfd	
() C24	.01 mfd	
() C4	.22 mfd	224
() C11	.22 mfd	
() C18	.22 mfd	
() C25	.22 mfd	

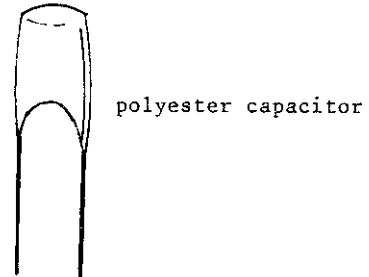

Up to this point, all components have been non-polarized. Electrolytic capacitors ARE POLARIZED. Just like a battery, they have a (+) and a (-) lead; and like a battery, if installed incorrectly the circuit won't work. The capacitors supplied will have either the (+) or the (-) lead marked on the body of the part. The (+) lead MUST go through the circuit board marked (+). In the event the capacitors have their (-) lead marked, this lead should go through the unmarked hole on the circuit board.

NOTE THAT THE SPECIFIED VOLTAGE RATING IS A MINIMUM. CAPACITORS SUPPLIED WITH SPECIFIC KITS MAY HAVE A HIGHER VOLTAGE RATING THAN THAT CALLED FOR.

DESIGNATION	VALUE
() C5	5 mfd / 16 volt
() C12	5 mfd
() C19	5 mfd
() C26	5 mfd
() C6	10 mfd / 16 volt
() C7	10 mfd
() C13	10 mfd
() C14	10 mfd
() C20	10 mfd
() C21	10 mfd
() C27	10 mfd
() C28	10 mfd

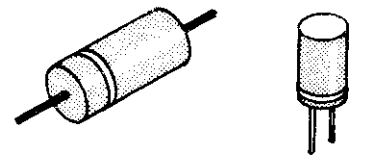

THIS COMPLETES PRELIMINARY ASSEMBLY OF THE 6760 CIRCUIT BOARD. Temporarily set this board aside and proceed to the installation of front panel jacks and controls.

INSTALLATION OF CONTROLS AND JACKS

- () Using the nuts and flat washers provided, mount the eight 1/4" open circuit phone jacks in the locations shown in figure 2. See the illustration supplement. Orient as illustrated and fasten securely in place.
- () Cut an 8 inch (20cm) length of bare wire and use it to connect together the ground lugs (lug #2) of J1-J8. As shown in figure 2, this ground wire terminates at J7 and J8. DO NOT SOLDER ANY OF THESE CONNECTIONS. Make sure that the wire does not contact any portion of the jack except the ground lug.

In the following steps, before each potentiometer is mounted a pair of pliers should be used to twist off the locating tab adjacent to the threaded mounting shaft.

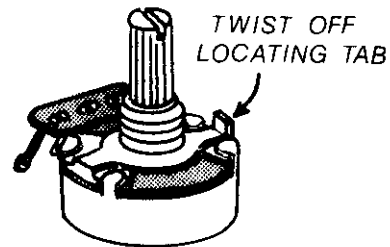

- () Mount the four 100K potentiometers R15, R33, R51 and R69 in the locations shown in figure 2. Orient the pots as indicated and fasten in place with the nuts provided. Tighten the mounting nut securely.
- () In a similar manner mount the four 500K potentiometers R17, R35, R53 and R71 and orient as illustrated.
- () Using four short lengths of bare wire (resistor clippings), form and install jumpers between lugs #2 and #3 of the 500K potentiometers installed above. Solder the connection at lug #2, but DO NOT SOLDER THE CONNECTION AT LUG #3 AT THIS TIME. See figure 2.
- () In a similar manner mount the four dual 100K section potentiometers R16, R34, R52 and R70. Orient as illustrated.

In the following steps we will begin wiring the front panel by using the co-axial cable supplied to make connections to the 8 phone jacks. In later steps the free end of these wires will connect to the circuit board. At each step, cut to the length specified and prepare both ends of the co-ax by first stripping 1/2 inch (-cm) of the outer insulation from EACH end. At one end, use your wire clippers to carefully cut the braided shielding wires off flush with the end of the outer insulation jacket. At the other end,

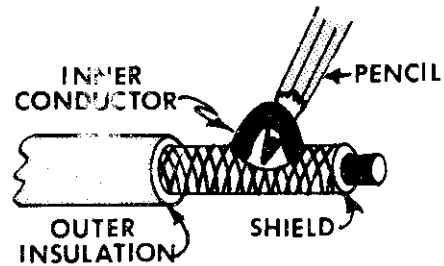

"un-braid" the exposed shielding wires. Pull all the wires to one side and tightly twist together and "tin" the twisted braid by melting a small amount of solder into the group of wires. Complete the cable preparation by stripping 1/4" (0.6 cm) of the insulation from the inner conductor at EACH end of the co-ax. "Tin" the exposed inner conductors.

NOTE that the wiring of J2 is slightly different and will be covered in a later step.

CO-AX LENGTH	TO JACK #
() 13-1/2" (34cm)	J1 (shield to lug #2; center to lug #1)

NO CONNECTION TO J2 AT THIS TIME

() 12" (30cm)	J3
() 10" (25cm)	J4
() 8" (20cm)	J5
() 8-1/2" (21cm)	J6
() 7" (18cm)	J7
() 7-1/2" (19cm)	J8

- () In a similar manner, prepare an 11-1/2" (29cm) length of co-ax to use for the connection at J2. Unlike previous co-ax lengths, THE SHIELD IS LEFT INTACT AND TWISTED AND TINNED AT BOTH ENDS. Connect and solder the center conductor to lug #1 of J2 and the shield to lug #2.

WE WILL NOW MOUNT THE CIRCUIT BOARD TO THE FRONT PANEL

- () Attach the two "L" brackets provided to the circuit board by passing a 4-40 X 1/4" machine screw through the mounting holes from the conductor side of the board. On the component side of the board, slip the unthreaded hole in the bracket over the screw and fasten in place with a lock-washer and 4-40 nut.
- () Attach the circuit board to the front panel by aligning the threaded holes in the "L" brackets installed above with the corresponding holes in the front panel. Fasten in place with two 4-40 X 1 4" screws passed through the front panel. Tighten securely.

- () Locate the co-ax originating at J2. Connect and solder the center conductor to circuit board point "1M" and the shield to the adjacent hole marked with the ground symbol(\equiv).

Now the remaining lengths of co-ax previously connected to J1 and J3-J8 will be connected and soldered to their respective circuit board points. See figure 3 of illustration supplement. NOTE that only the center conductors connect to the circuit board point (the shield from these ends were cut off in previous steps). Solder each connection as it is made.

FROM TO P.C. POINT

- () J1 1N

J2 PREVIOUSLY CONNECTED

- () J3 2N
 () J4 2M
 () J5 3N
 () J6 3M
 () J7 4N
 () J8 4M

After completing installation of these lengths of co-ax, dress them so that they are against the front panel under potentiometers. They will be held in these positions by the single stranded wires which will be installed next.

Now the stranded insulated wire provided will be used to connect the front panel controls to the circuit board. At each step, strip 1/4" of insulation from each end of the wire. "Tin" each end of the wire by twisting the exposed strands tightly together and melting a small amount of solder into the wire. Solder each connection as it is made. See figure 4 of illustration supplement.

WIRE LENGTH	FROM	TO P.C. POINT
() 4" (10cm)	R15 lug #1	1C
() 3-1/2" (9cm)	R15 lug #2	1B
() 3-1/2" (9cm)	R15 lug #3	1A
() 3-1/2" (9cm)	R17 lug #1	1K
() 3-1/2" (9cm)	R17 lug #3	1L
() 3-1/4" (8cm)	R16 lug #1	1J
() 3-1/4" (8cm)	R16 lug #2	1H
() 3-1/4" (8cm)	R16 lug #3	1G
() 3-1/2" (9cm)	R16 lug #4	1F
() 3-1/2" (9cm)	R16 lug #5	1E
() 3-1/2" (9cm)	R16 lug #6	1D
() 3-1/2" (9cm)	R33 lug #1	2C
() 3" (7.5cm)	R33 lug #2	2B
() 2-1/2" (6.5cm)	R33 lug #3	2A

() 2-3/4" (7cm)	R35 lug #1	2K
() 2-3/4" (7cm)	R35 lug #3	2L
() 2-3/4" (7cm)	R34 lug #1	2J
() 2-3/4" (7cm)	R34 lug #2	2H
() 2-3/4" (7cm)	R34 lug #3	2G
() 3-1/4" (8cm)	R34 lug #4	2F
() 3-1/4" (8cm)	R34 lug #5	2E
() 3-1/4" (8cm)	R34 lug #6	2D
() 3-1/4" (8cm)	R51 lug #1	3C
() 3-1/4" (8cm)	R51 lug #2	3B
() 3-1/4" (8cm)	R51 lug #3	3A
() 2-3/4" (7cm)	R53 lug #1	3K
() 2-3/4" (7cm)	R53 lug #3	3L
() 2-3/4" (7cm)	R52 lug #1	3J
() 2-3/4" (7cm)	R52 lug #2	3H
() 3" (7.5cm)	R52 lug #3	3G
() 3-1/4" (8cm)	R52 lug #4	3F
() 3-1/4" (8cm)	R52 lug #5	3E
() 3-1/4" (8cm)	R52 lug #6	3D
() 2-3/4" (7cm)	R69 lug #1	4C
() 2-3/4" (7cm)	R69 lug #2	4B
() 2-3/4" (7cm)	R69 lug #3	4A
() 2-1/2" (6.5cm)	R71 lug #1	4K
() 2-1/2" (6.5cm)	R71 lug #3	4L
() 2-1/2" (6.5cm)	R70 lug #1	4J
() 3" (7.5cm)	R70 lug #2	4H
() 3-1/4" (8cm)	R70 lug #3	4G
() 3-1/2" (9cm)	R70 lug #4	4F
() 3-1/2" (9cm)	R70 lug #5	4E
() 3-1/2" (9cm)	R70 lug #6	4D

Complete assembly of the Equalizer by installing the integrated circuits. Note that the orientation of these IC's is keyed by a circular indentation or notch at one end of the case. This notch aligns with the semicircular key drawn on the circuit board parts designators. Install each IC by carefully inserting its pins into the receptacles of the sockets installed previously. Press the integrated circuit firmly into place and take care that pins of the IC do not fold under the device.

DESIGNATION	TYPE
() IC1	4136 quad op-amp
() IC2	4136
() IC3	4136
() IC4	4136

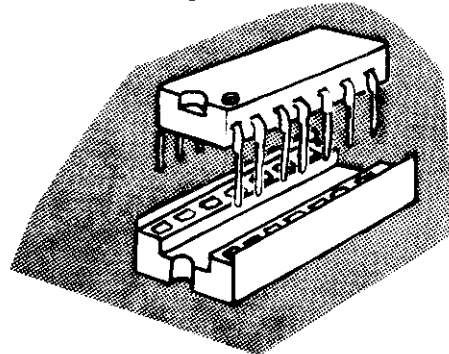

Install the knobs by rotating all the control shafts fully counter-clockwise. For each control, place the knob on the shaft and align its pointer with the 7:00 o'clock position of an imaginary clock face and tighten the setscrew.

THIS COMPLETES ASSEMBLY OF THE 6760 PARAMETRIC EQUALIZER

TESTING

The equalizer can run from virtually any type of bi-polar supply from +/- 9vdc to +/- 15vdc; the higher the supply voltage, the higher the overall headroom.

Power Connection

The power input connection (header symbol) is at the left side of the circuit board. Header and connector components are no longer available so we recommend direct connection to the circuit board. The positive supply is connected between the top hole(+) and the bottom hole (ground symbol). Connect the negative supply between the next hole down (unmarked) and the bottom hole (ground symbol).

With power applied to the equalizer, confirm the operation of each stage by applying a signal to the input and listening to the resulting output as all controls are varied.

PARAMETRIC APPLICATIONS

by Craig Anderton

Parametrics are excellent "problem solving" equalizers that can provide very precise frequency response alterations. For example, suppose that you have a resonant peak in an instrument (this is often the case with acoustic instruments). You can simply dial in the resonant frequency with the parametric's frequency control, and then adjust the cut control for the right amount of de-emphasis at this frequency. If the peak is very sharp, then the filter will need a fair amount of resonance; broader peaks will not require as much resonance.

Another parametric application involves analog delay lines. Many solid state echo units can produce quite long delays; however, with some designs there may be a low-level, high-frequency audio tone present along with the delayed output signal (this tone is caused by feedthrough from the clock driver feeding the delay line.) Any constant high-frequency tone can really be quite grating, but a parametric equalizer solves the problem. Select the frequency of the objectionable tone with the filter's frequency control, set the boost/cut control for full cut. This will eliminate, or at least drastically reduce, the feedthrough from the clock.

A final application involving frequency-cutting involves processing the sound of instruments such as PAiA's ORGANTUA (cat# 6780). The predominantly square wave output of this instrument contains lots of high-frequency harmonics. By setting the parametric for a relatively high resonant frequency (say, around 15kHz) with little resonance and as deep a cut as possible, you'll be able to take away the very highest highs while leaving the mid-range intact.

Boosting can also be extremely useful. For example, one of the differences between electronic and acoustic instruments is that acoustic instruments tend to have resonance peaks and dips that contribute a certain kind of timbral character to a sound. A parametric can add these kinds of peaks and dips; adding a couple of peaks to the responds of a string simulator, or adding a boost at around 3- to 4 kHz. when synthesizing guitar sounds produces a more realistic (and interesting) sound. Boosting can also cover for response deficiencies in either your instrument or amplification system. Suppose that you have a great instrument, but that your amplifier poops out a bit at the high end. No problem - just boost the treble range with the parametric.

SERIAL CONNECTION OF PARAMETRIC SECTIONS

One of the great advantages of a parametric filter stage is that you can connect several of them in series, as shown in figure 5. This multiple-stage connection

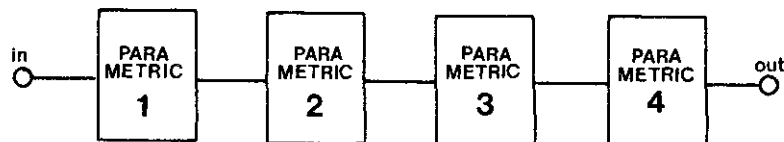

Figure 5: Series hookup of parametric stages

means that each stage can boost or cut a particular section of the audio spectrum. For example, the first stage could provide a bass boost, the second a lower midrange cut to prevent muddiness, the third a midrange boost to add a little character, and the fourth a bit of treble boost to give some extra sheen or brightness.

RESONANCE CONTROL TIPS

I was producing a session at a studio once where I needed parametric equalization on a particular instrument. The engineer assured me that I didn't want to use a parametric because they are so "plastic sounding". I asked him for a listen; and his equalizer sure did sound terrible - but the problem didn't lie with the circuit. Instead, the problem was that he had never tried low resonance settings. While high resonance effects are obvious and can be dramatic, it's often the more subtle settings that provide the best-sounding equalization. So don't automatically assume that you need lots of boost, cut, or resonance to accomplish a given effect - go for the most natural sound first, and if that isn't extreme enough, then experiment with adding more emphasis.

Finally, note that the filter inverts the phase of your signal. Therefore, placing this filter in parallel with a non-inverting electronic stage will produce some degree of cancellation. For a non-inverting parametric, putting two equalizer stages in series will give you a non-inverted output at the output of the second stage; in fact, any even number of parametric stages placed in series will produce a non-inverting output.

ASSEMBLY DRAWINGS

Remove this section for easy reference during assembly

ASSEMBLY DRAWINGS

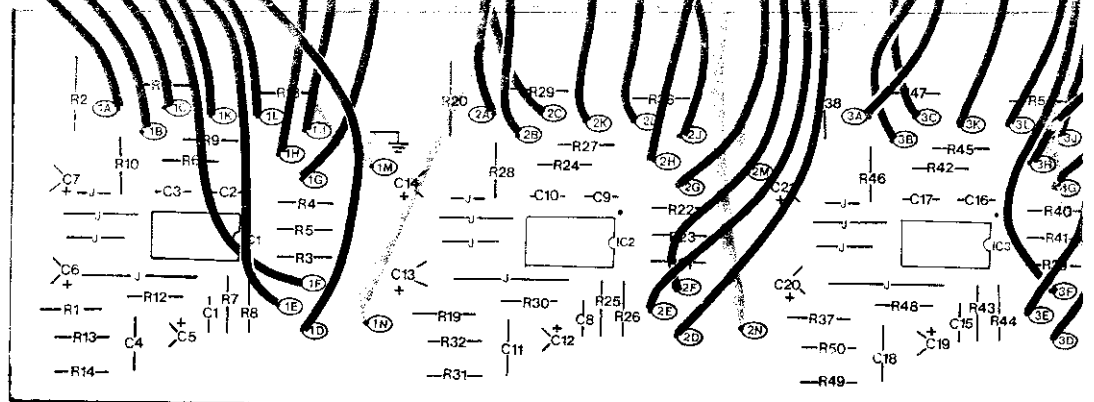
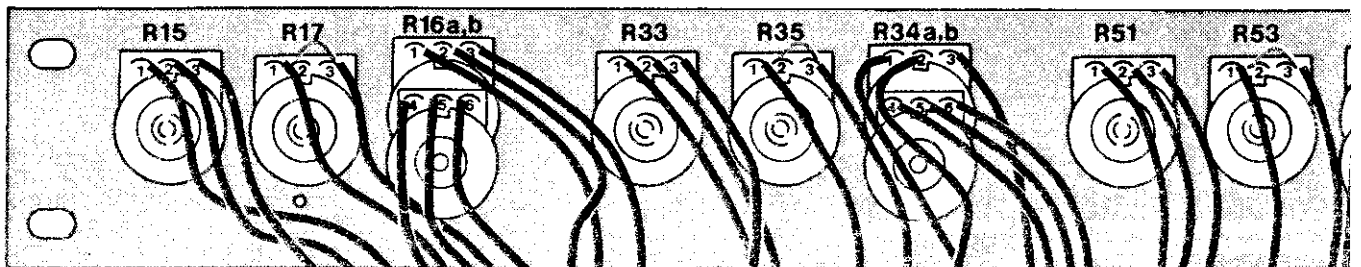
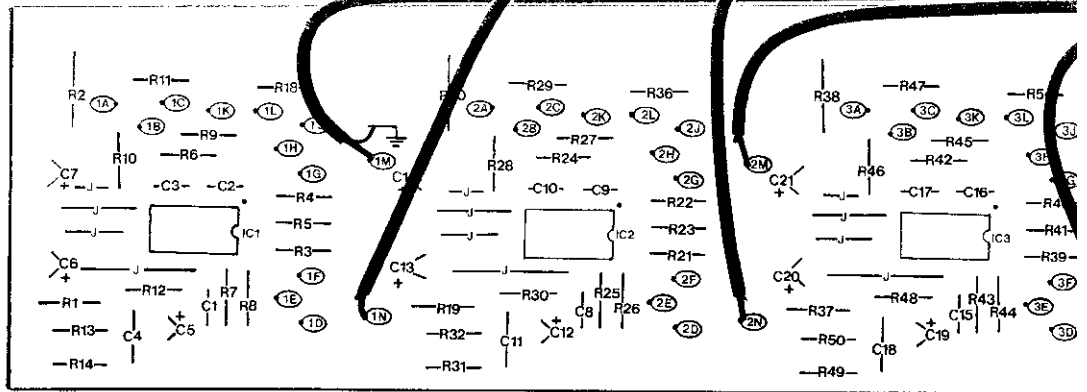
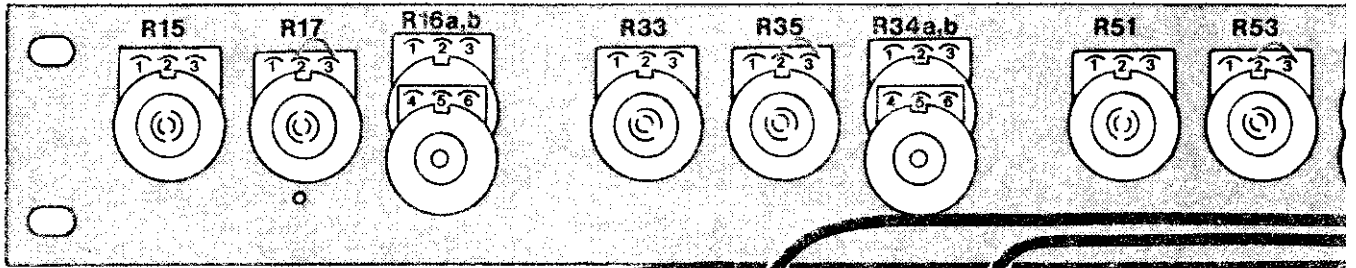
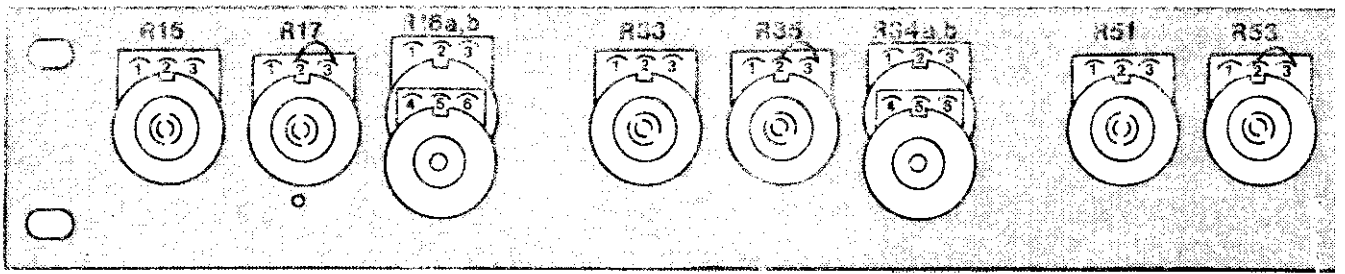

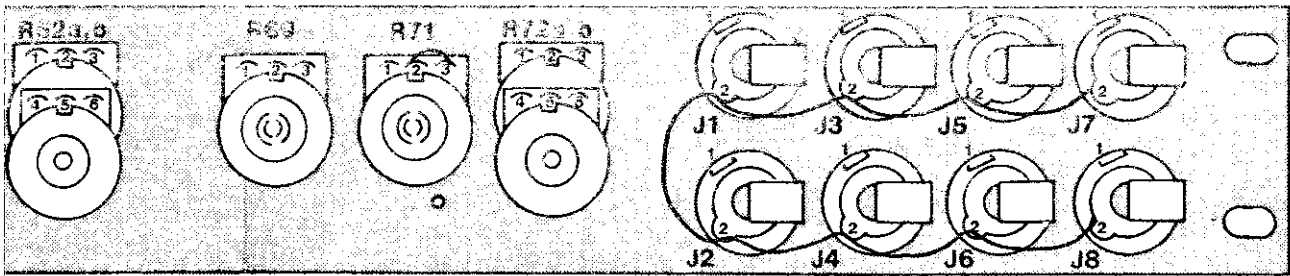

Figure 2: Orientation of controls and jacks, GROUND wire installation

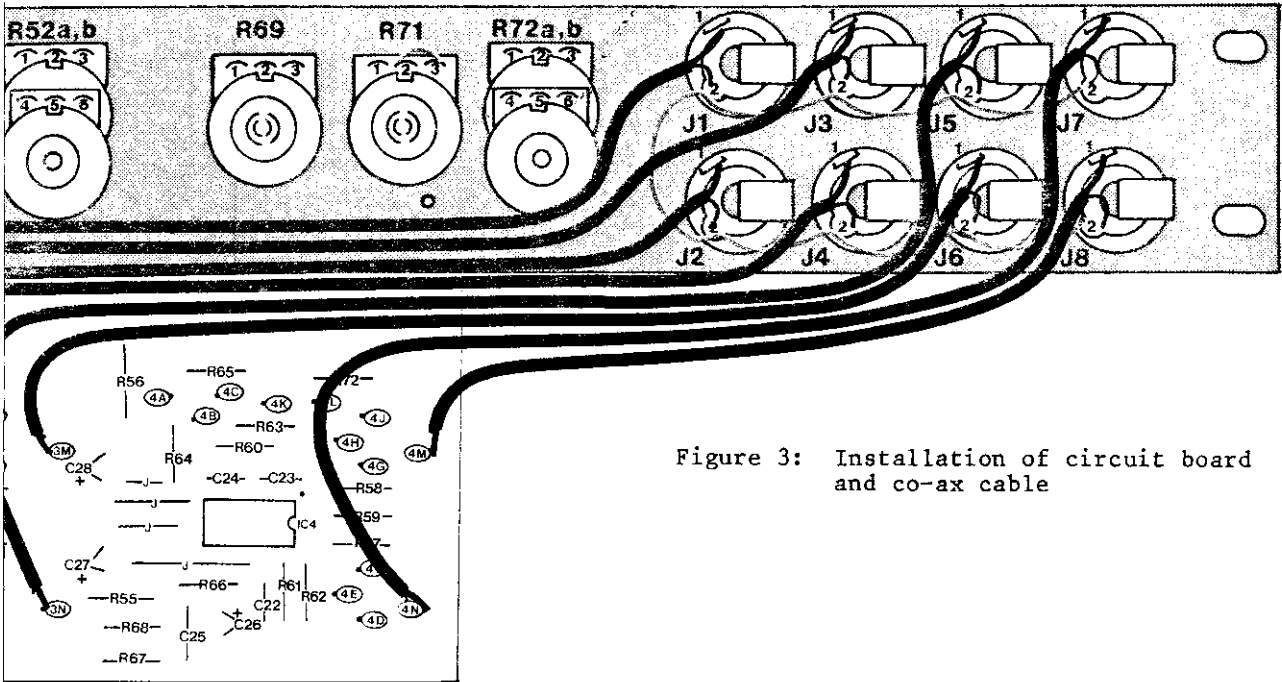

Figure 3: Installation of circuit board and co-ax cable

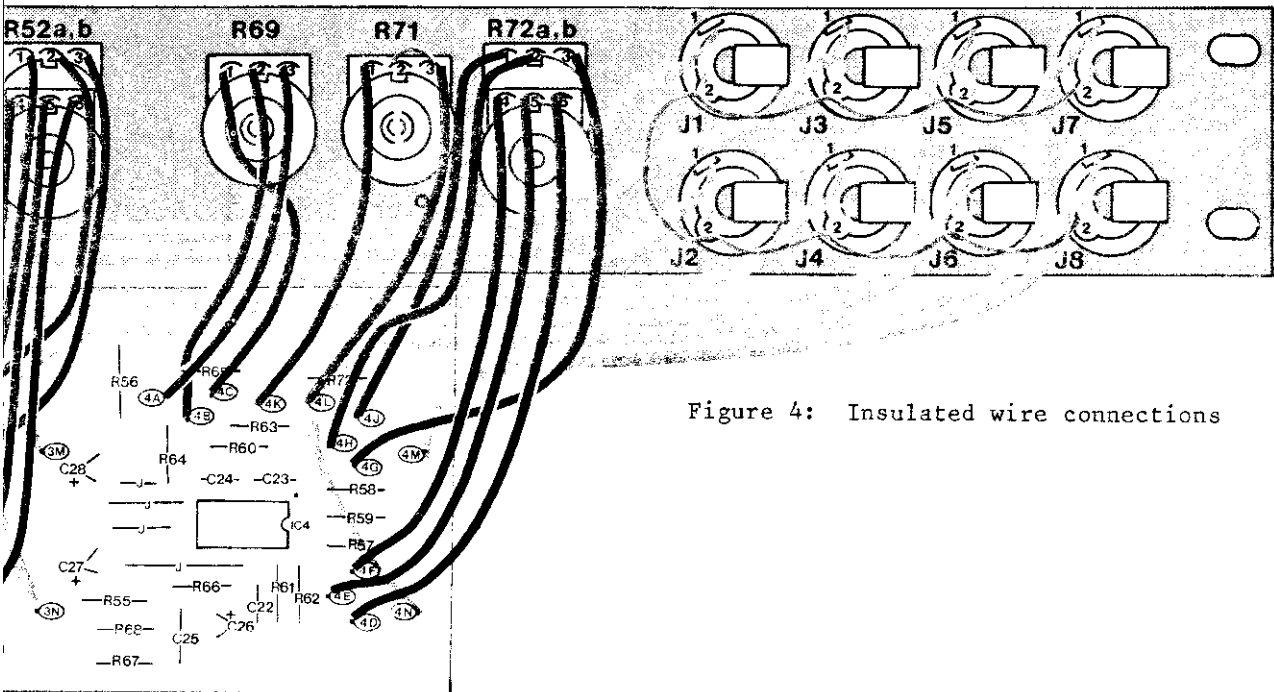

Figure 4: Insulated wire connections

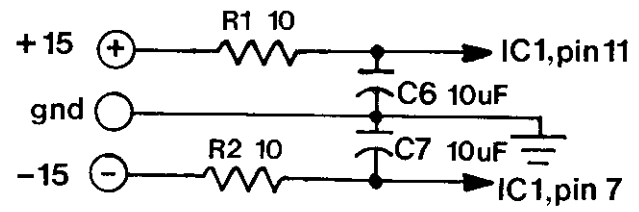
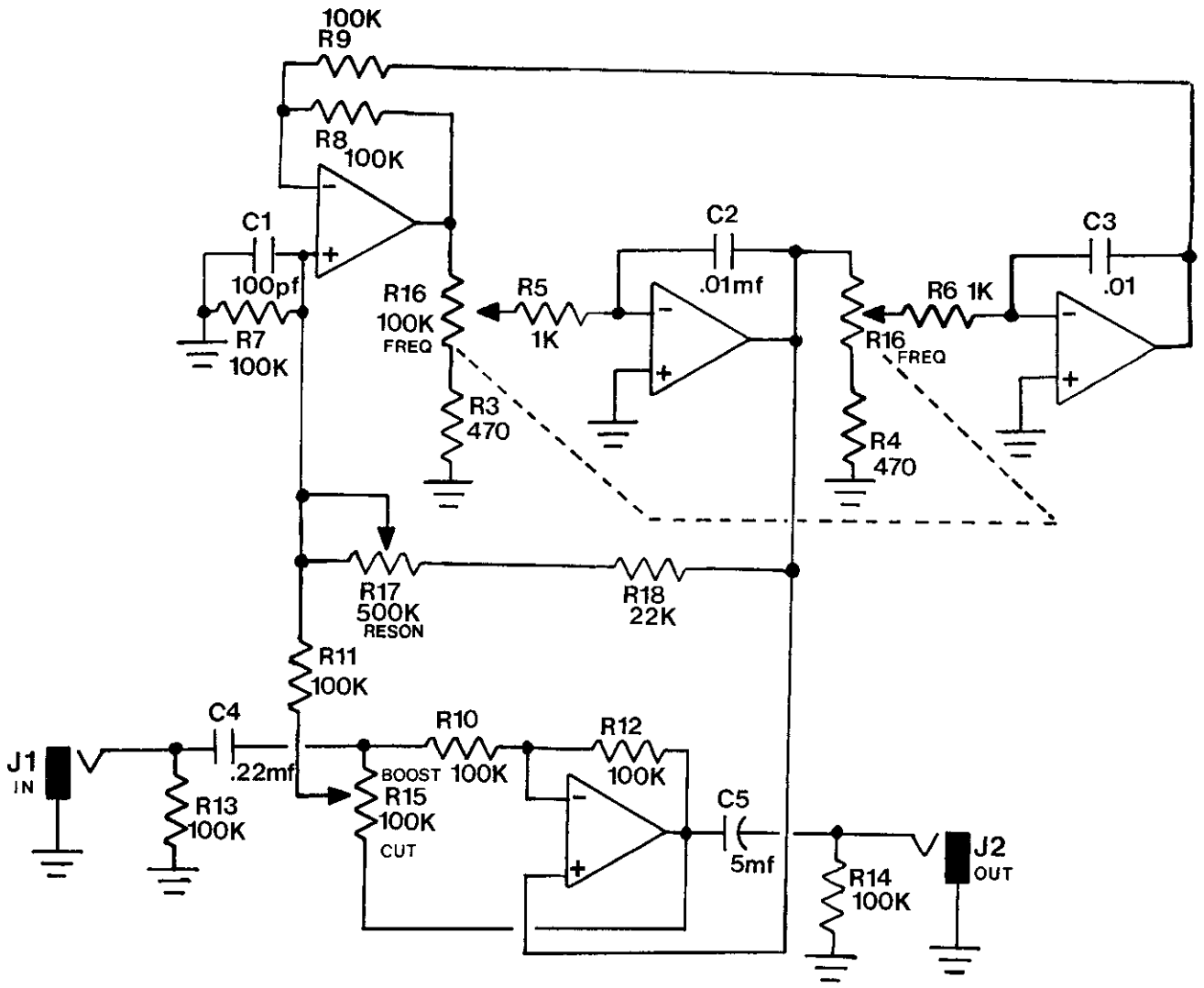

Figure 6: schematic 1 of 4 stages
Designation for stage 4 shown