

# PAiA midi2cv8

Model 9700  
Assembly and Using Manual  
*includes 9700frm and 9700vzh*

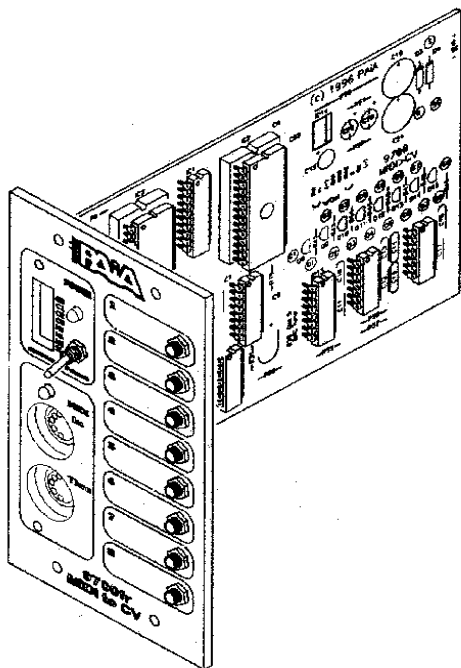

This MIDI to CV converter from PAiA is an economical and versatile solution for interfacing MIDI to the world of analog synthesis and control. It is an easy to build and use system with eight analog outputs that can be Control Voltages, Gates, Triggers, even DIN sync and variable amplitude pulses for triggering analog drum sets. Open collector transistors on each output provide for "S" and Wired-or Triggers and a MIDI Thru jack allows easy expansion through daisy-chaining.

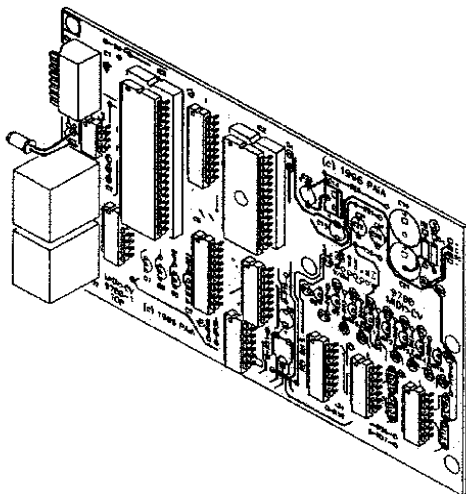

---

## ASSEMBLING THE midi2cv8

Before beginning assembly, go through the manual. Look at the drawings. Feel the parts. You're naturally eager to plunge right in, but take a few deep breaths first.

*In some cases, notes packed with the parts will be used to call your attention to special situations. These notes may be in the yellow "MISSING PARTS" postcard. If parts are missing please notify PAiA at p405-340-6300, f340-6378, or missing@paia.com .*

Notice that each step in the manual is marked with a checkoff box like this:

DESIGNATION	VALUE	COLOR CODE
( ) R27	100 ohm	brown-black-brown

Checking off each step as you do it may seem silly and ritualistic, but it greatly decreases the chance of omitting a step and also provides some gratification and reward as each step is completed.

Numbered figures are printed in the Illustrations Supplement in the center of this manual. These pages may be removed for easy reference during assembly.

## THE CIRCUIT BOARD

The midi2cv8 is built on a double-sided, plated through-hole circuit board. The solder side of the board is solder masked with a conformal coating and pads are tin-lead plated for ease of soldering and assembly. No cleaning of the circuit board or other special preparation is necessary before beginning assembly.

## TOOLS

You'll need a minimum of tools to assemble the kit - a small pair of diagonal wire cutters and pliers, wire stripper, screwdriver, sharp knife, ruler, soldering iron and solder.

Modern electronic components are small (in case you hadn't noticed) and values marked on the part are often difficult to see. Another handy tool for your bench will be a good magnifying

---

glass. Also use the magnifier to examine each solder joint as it is made to make sure that it doesn't have any of the problems described in the SOLDERING section which follows.

## **SOLDERING**

Select a soldering iron with a small tip and a power rating not more than 35 watts. Soldering guns are completely unacceptable for assembling solid state equipment because the large magnetic field they generate can damage components.

Use only rosin core solder (acid core solder is for plumbing, not electronics work). Solder is commonly sold in several different diameters, a relatively small (.031) diameter is recommended because larger sizes make it difficult not to get too much solder on a joint. A proper solder joint has just enough solder to cover the soldering pad and about 1/16-inch of lead passing through it. There are two improper connections to beware of: Using too little solder will sometimes result in a connection which appears to be soldered when actually there is a layer of flux insulating the component lead from the solder bead. This situation can be cured by reheating the joint and applying more solder. If too much solder is used on a joint there is the danger that a conducting bridge of excess solder will flow between adjacent circuit board conductors forming a short circuit. Accidental bridges can be cleaned off by holding the board upside down and flowing the excess solder off onto a clean, hot soldering iron.

Use care when mounting all components. Never force a component into place.

### ***Notes on this manual:***

I've tried to cover a lot of ground in this one manual, having it serve for midi2cv8 with or without the V/Hz. adapter board and also assembly of the FracRak accessory kit. Because of this there may be large sections of the manual that you will skip over. For example, if you will be fitting a V/Oct tempered midi2cv8 into a custom package or retro-fitting to existing gear you will only be concerned with assembly of 9700-1 board on pages 4 to 11 and the Testing and Using and Design Analysis sections beginning on page 19. I've tried to make the transition points between sections obvious, and instructions on which sections are to be performed for which options clear, but you should also think a little about which options you are implementing before you begin assembly. I cannot overemphasize the value of at least paging through the manual once before starting work.

*-John Simonton*

Special thanks to Scott Lee for being so retentive, and right, and to Saul Stokes for keeping me washed in mercury.

## Resistors

Solder each resistor in place following the parts placement designators printed on the circuit board and the assembly drawing fig 1. Note that resistors are nonpolarized and may be mounted with either lead in either of the holes in the board. Before mounting each resistor, bend its leads so that they are at a right angle to the body of the part. Put the leads through the holes and then push the resistor firmly into place. Cinch the resistor in place by bending the leads on the solder side of the board out to an angle of about 45 degrees. Solder both ends of each resistor in place as you install it. Clip each lead flush with the solder joint as the joint is made. Save a few long lead clippings for use as jumpers in later steps.

A tip: If you can't find the location for a resistor, go on to the next one and come back. Do not check off a part until it is installed and soldered. *Note that #R32 and \*R28 are not installed now, we will deal with them later.*

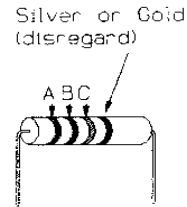

DESIGNATION	VALUE	COLOR CODE A-B-C	
( ) R41	1000	brown-black-red	
( ) R52	100	brown-black-brown	
listed below:	10k	brown-black-orange	
( ) R23	( ) R24	( ) R25	( ) R27
( ) R53			
listed below:	100k	brown-black-yellow	
( ) R34	( ) R35	( ) R36	( ) R37
( ) R16	220	red-red-brown	
( ) R30	220	red-red-brown	
( ) R33	220	red-red-brown	
( ) R15	330	orange-orange-brown	
( ) R19	2700	red-violet-red	
listed below:	33k	orange-orange-orange	
( ) R39	( ) R40	( ) R42	( ) R43
( ) R44	( ) R45	( ) R46	( ) R47
( ) R48	( ) R49		
( ) R51	47	yellow-violet-black	
( ) R6	4700	yellow-violet-red	
( ) R54	4700	yellow-violet-red	
( ) R31	2200	red-red-red	

One of the final resistors to be mounted on the circuit board is in fact two parts. Locate the two 15 ohm (brown-green-black) 1W resistors. These are roughly twice the size of the 1/4W resistors used in the previous steps. Twist and solder one lead of each together before folding the resistors as shown in the illustration. Install by pushing the two leads of the composite part through the holes in the circuit board. These parts will get very warm during operation and this mounting will allow free air flow around them for cooling. Solder in place and clip the leads off flush with the solder joint.

( ) R50            30 ohm 2W.    as detailed above.

### Ceramic Disk and Mylar Capacitors

Some of the capacitors used in the midi2cv8 are non-polarized Ceramic Disk and Mylar types. For all of these, either lead can go in either of the holes in the circuit board. The leads of the capacitors are already parallel to each other but still may need to be bent slightly to match the spacing of the circuit board holes. Like the resistors, insert the leads of these parts through the holes in the board and push the part against the circuit board as far as it wants to go. Don't force it, it's OK if it sits a little off the board. Solder both leads of each part and clip the excess off flush with the solder joint.

Capacitors are often marked with obscure codes that indicate their values. The 3 digit number that specifies value may be preceded or followed by letters indicating such things as tolerance. If you get confused about which capacitors are which, it may help to group them by same type and check them against quantities on the packing list at the end of this manual.

### Ceramic Disk Capacitors

DESIGNATION	VALUE	MARKING	
( ) C24	0.005	502 (or 0.0047uF marked 472)	
<i>listed below:</i>	0.01	103	
( ) C4	( ) C5	( ) C6	( ) C7
( ) C2	33pF	33	
( ) C3	33pF	33	

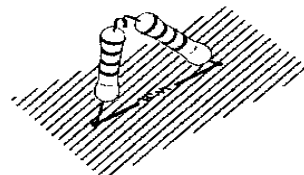

Fold so that soldered tail is down and push free leads through holes.

Capacitors  
Ceramic Disk    Mylar

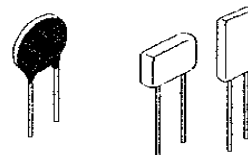

## Mylar Capacitors

Since all eight Mylar Capacitors are the same value, there is little chance of confusion among the parts. Clip excess leads.

Mylar Capacitors

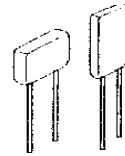

DESIGNATION	VALUE	MARKING	
<i>listed below:</i>	0.1uF	104	
( ) C10	( ) C11	( ) C12	( ) C13
( ) C14	( ) C16	( ) C17	( ) C18

## Electrolytic Capacitors

The remaining capacitors are electrolytic types. Unlike the previous components, electrolytic capacitors are polarized and the leads are not interchangeable. Leads are marked "+" and/or "-" and the "+" lead must go through the "+" hole in the circuit board. Frequently the positive lead of the capacitor is significantly longer than the negative lead.

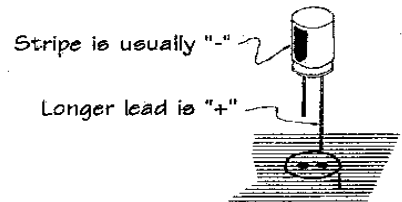

Usually the Negative lead of the capacitor is marked rather than the positive. It naturally goes through the unmarked hole. Solder each part in place as it is installed and clip off excess leads.

Capacitors supplied with specific kits may have a higher Voltage (V) rating than the minimum specified below.

DESIGNATION	VALUE
( ) C1	10uF / 16V
( ) C15	10uF / 16V
( ) C8	2.2uF / 16V
( ) C20	220uF / 16V
( ) C22	220uF / 16V
( ) C19	2200uF / 25V
( ) C21	2200uF / 25V
( ) C23	470uF / 16V (25V volt may be supplied)

## Diodes

Two types of diodes are used in the midi2cv8, one 1N4148 silicon signal diode in a small glass case and two 1N400x power diodes in larger cases.

Like the Electrolytic Capacitors, diodes are polarized and must be installed so that the lead on the banded end of the part corresponds to the banded end of the designator on the circuit board. Bend the leads so they are at right angles to the body of the part and insert them through the holes provided in the circuit board.

1N400x diodes are in larger cases.



1N914 / 1N4148 diodes are in smaller cases

Diodes are also somewhat heat sensitive so the soldering operation should be done as quickly as possible. Solder each part in place as it is installed and clip off excess leads.

DESIGNATION	TYPE
( ) D1	1N914 / 4148 Silicon Signal Diode
( ) D3	1N400x Power Diode
( ) D4	1N400x Power Diode

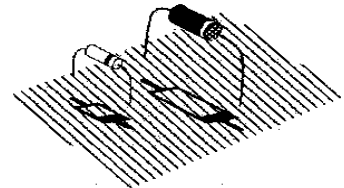

Note polarizing color bands

### Transistors

Install the transistors by inserting their three leads through the holes provided for them in the circuit board. Note that the transistors are polarized by the flat side of the case. When the transistors are properly installed this flat will align with the corresponding mark on the circuit board legending.

Solder each part in place as it is installed and clip off excess leads.

DESIGNATION	TYPE
<i>listed below:</i>	2N4124 NPN Silicon Transistor
( ) Q4	( ) Q5                      ( ) Q6                      ( ) Q7
( ) Q8	( ) Q9                      ( ) Q10                      ( ) Q11
( ) Q12	( ) Q13                      ( ) Q14                      ( ) Q15

### Trimmer Potentiometer

Mount the trimmer potentiometer by inserting its three pins into the holes provided. Press it down until the "shoulders" of the solder pins are resting on the surface of the circuit board. Solder all three pins.

DESIGNATION	VALUE
( ) R29	1000 (1k) ohms      102

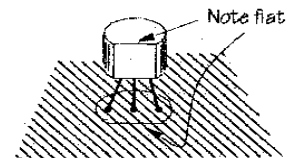

The straight line of the pc graphic symbol corresponds to the flat face of the transistor case.

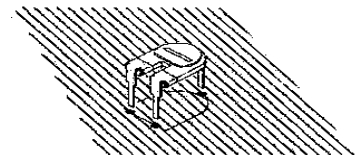

## CRYSTAL - X1

- ( ) Locate the 12 mHz. crystal. This part is nonpolarized and is installed at the location marked X1 on the circuit board (between C2 and C3.) Insert the leads through the holes in the circuit board, solder both leads and clip the excess off flush with the solder joint.

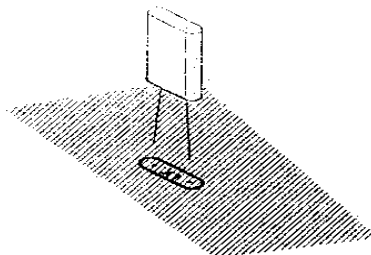

## DEFAULT DIP SWITCH - S1

Locate the 8 position DIP Switch. Notice that the switch is polarized by the "piano" style switch bats coming out of one side. Make sure that the DIP package is mounted so that these bats come out of the side of the package closest to the edge of the circuit board.

- ( ) Install the 8-position DIP switch by soldering pins in diagonal corners of the pattern. Check to make sure that the switch bats point to the closest edge of the circuit board and the package is firmly seated against the board before soldering the remaining pins.

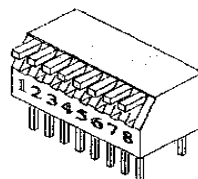

## DIN Sockets

The 5-pin DIN sockets that are the MIDI connectors mount on the circuit board. Push the 7 pins of each connector through the holes provided in the circuit board and make sure it is pushed down fully against the board before soldering in place.

DESIGNATION      TYPE

- ( ) J1    5 pin pc mount DIN
- ( ) J2    5 pin pc mount DIN

## IC Sockets

Sockets are notorious for being the weak links in the chain of connections between electronic components. We use them only in places where their advantages outweigh their lack of reliability. The PROM is socketed so that it can be easily changed for upgrades.

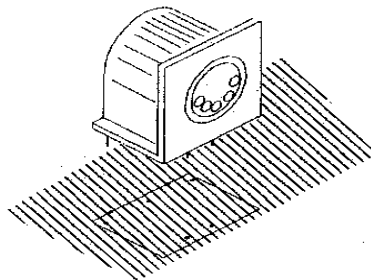



The 8031 uC is socketed for peace of mind - so that if trouble shooting is needed it can be easily removed and/or replaced. Less expensive "glue" logic is soldered directly to the board.

Sockets are polarized with a rectangular or semicircular notch at one end of the part which corresponds to a similar indicator on the circuit board graphics. The socket would work just as well if it were inserted backward to the marked polarity, but this would surely generate confusion when the time came to install or replace the ICs.

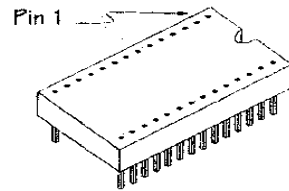

Insert the socket in the circuit board holes and initially solder two pins in diagonal corners of the pattern. Make sure that the socket is seated firmly against the pc board by pressing it down while remelting the solder joint at first one corner, then the other. Finally, solder the remaining connections. If it seems that you are feeding a lot of solder to a joint, stop and check to make sure that it is not flowing through the hole and accumulating on the component side of the board or "wicking" into the sockets pins.

#### DESIGNATOR    SOCKET TYPE

( ) IC2	28 pin
( ) IC3	40 pin

#### Integrated Circuits

Of all the parts, the ICs are the most easily damaged and should be treated with some respect. In particular, they may be destroyed by discharges of static electricity. Modern ICs are not nearly as sensitive to this kind of damage as were earlier versions, but it is still good practice to handle these parts as little as possible. Also good practice: don't wear nylon during assembly. Don't shuffle around on the carpet immediately before assembly (or if you do, touch a lamp or something to make sure you're discharged). Don't be intimidated. It's rare for parts to be damaged this way.

ICs are polarized in one or both of two ways; A dot formed into the case of the IC corresponding to pin 1 or a semicircular notch that indicates the end of the package with pin 1. Take care that this polarizing indicator corresponds to the similar indicator on the circuit board graphics.

The pins of the ICs may be splayed somewhat and not match the holes in the circuit board exactly. Carefully re-form the leads if necessary so that they are at right angles to the part.

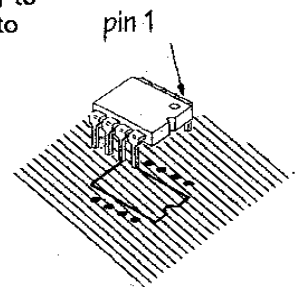

Using the same procedure as with the sockets, solder each IC in place as it is installed.

DESIGNATION	PART NO.	DESCRIPTION
( ) IC13	4051	1/8 Mux Demux
( ) IC5	6N138	Opto Coupler
( ) IC6	74HC14	Hex Inverter
( ) IC1	74HC373	8 Bit Latch
( ) IC7	74HC373	8 Bit Latch
( ) IC8	DAC08	8 Bit DAC
( ) IC10	LM324	Quad OpAmp
( ) IC11	TL084	Quad OpAmp
( ) IC12	TL084	Quad OpAmp

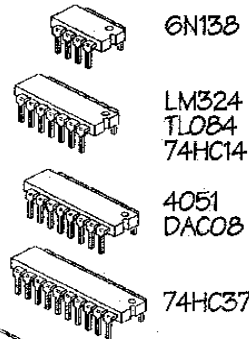

### uController, PROM

( ) Install the 8031/8051 uC and 2764 PROM with midi2cv8 firmware in the sockets at IC3 and IC2 respectively. Make sure that pin 1 indicators on IC and socket agree and take extra time to assure that the IC pins are vertical and that each pin is in the socket hole before pushing the part firmly to seat it.

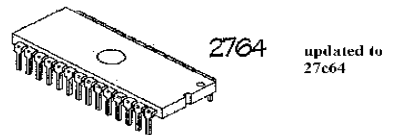
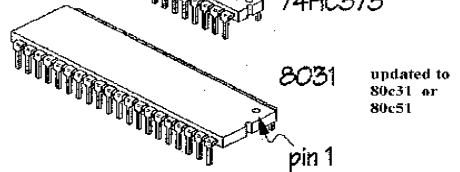

When the IC is in place, check to make sure that none of the pins have "rolled under" the IC rather than gone into the socket hole. If you find one, remove the IC by sliding a small blade under first one end, then other as you gently "rock" the part out of the socket. Straighten the pin and carefully re-install.

### Voltage Regulators

The voltage regulator is polarized and must be mounted so that its tab corresponds to the tab markings on the circuit board graphics. Solder all three leads and clip any excess off flush with the solder joint.

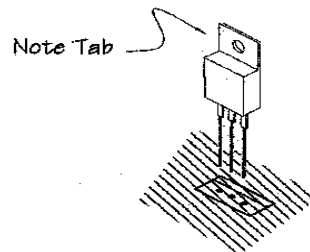

DESIGNATION	PART NO.	DESCRIPTION
( ) IC14	7805	+5V Voltage Regulator

## Light Emitting Diode

Note that the LED is polarized by the flat in the collar at the base of part. When properly installed, this flat will align with the corresponding flat in the LED symbol printed on the circuit board.

When the midi2cv8 is installed behind a front panel, the MIDI activity LED will engage the hole provided in the front panel and be supported by its leads. Push the two leads through the holes in the circuit board and space the LED above the board by about 5/8". Solder both leads and check the spacing from the board to the LED before trimming the leads off flush with the solder joint.

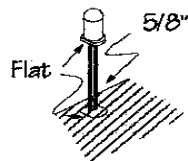

DESIGNATION	TYPE
( ) D2	Red LED

To this point assembly has proceeded without regard to whether a V/Hz adapter board was to be installed or not. If you will be installing the V/Hz board, skip ahead to the **V/Hz adapter** section of this manual beginning on the following page and do not perform the steps below.

If you **will not** be installing the V/Hz adapter board, use resistor clippings to make the jumper connections between the specified pads in the V/Hz adapter connection points. Leave a small loop that can be cut if you want to disable the jumper at a later date. Trim the excess on the bottom of the board flush with the solder joint.

FROM	TO	PURPOSE
( ) Out	In	bypass V/Hz loop
( ) OctC	G	tell uC no V/Hz.

- ( ) Finally, locate the 5600 ohm 1/4w fixed resistor (green-blue-red) and install it as R28. Solder both leads and clip the excess flush with the solder joint.

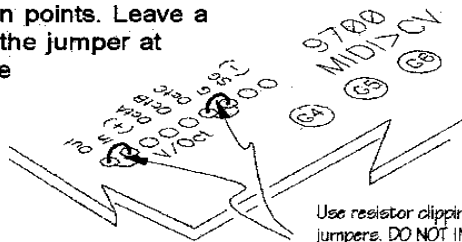

Use resistor clippings to form jumpers. DO NOT INSTALL JUMPERS IF YOU WILL BE USING A V/Hz ADAPTER

**This completes the electronic assembly of the midi2cv8 MIDI to CV Converter.** If you will be using the midi2cv8 for retrofit or custom applications proceed to the Testing and Calibration section of this manual starting on page 19. Assembling the optional FracRak Accessory Kit begins on page 14. If you will be using the Rack Mount Accessory Kit, follow the instructions in the manual which accompany the 9700rck kit.

## V/Hz Adapter Assembly

Before beginning the assembly of the 9700vHz V/Hz adapter board, take a break. Stretch, move around and think about something else for a while. When you return, begin the session by examining your work on the midi2cv8 board. Be critical of solder joints and re-heat any that are questionable. Review the soldering section for suggestions on cleaning up joints with too much solder.

When you're satisfied that all parts are in the right place and pointing the right way, if it matters, you need to add two final resistors to the midi2cv8 board.

DESIGNATION	VALUE	COLOR CODE A-B-C
( ) *R28	2700	red-violet-red
( ) #R32	2700	red-violet-red

Put the midi2cv8 board aside and proceed with assembly and installation of the 9700vHz adapter board.

### V/Hz adapter board assembly

Unpack the components in the 9700vHz parts bag and check them against the packing list on the last page of this manual.

Unlike the double-sided midi2cv8 circuit board, the 9700-2 board is single sided bare copper and oxidation will need to be removed from this board. Steel wool can be used to clean the board so that the copper is shiny. Do not use cleaning pads with soap for this operation because the soap will form a layer that prevents the copper from accepting soldering readily.

- ( ) Using a resistor clipping saved from previous steps, form and install the single wire jumper on the 9700-2 circuit board. Solder the jumper in place and clip the excess off flush with the solder joint.

Follow the previous procedures when installing the following parts on the circuit board (see fig 2).

### Resistors

DESIGNATION	VALUE	COLOR CODE A-B-C
<i>listed below:</i>	10k	brown-black-orange
( ) R1	( ) R2	( ) R3
( ) R5	( ) R7	( ) R4

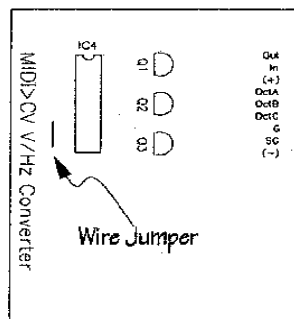

Silver or Gold  
(disregard)

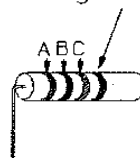

DESIGNATION	VALUE	COLOR CODE A-B-C
( ) R9	390	orange-white-brown
( ) R10	270	red-violet-brown
( ) R12	100	brown-black-brown
( ) R13	120	brown-red-brown
( ) R17	47	yellow-violet-black
( ) R22	47	yellow-violet-black
( ) R18	56	green-blue-black
( ) R21	22	red-red-black
( ) R26	22	red-red-black

### Integrated Circuit

DESIGNATION	TYPE	DESCRIPTION
( ) IC4	4051	1 of 8 Multiplexer Demultiplexer

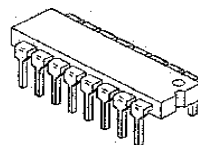

### Trimmer Potentiometers

DESIGNATION	VALUE			
<i>listed below:</i>	1k Trimmer pots			
( ) R8	( ) R11	( ) R14	( ) R20	

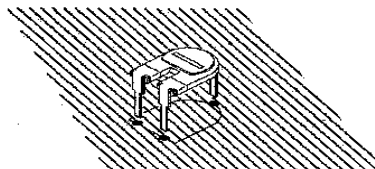

### Transistors

DESIGNATION	TYPE	
<i>listed below:</i>	2N4124 NPN Silicon Transistor	
( ) Q1	( ) Q2	( ) Q3

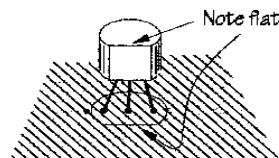

Prepare wires that will be used to make the electrical connections between the midi2cv8 board and V/Hz Adapter board. Wire kinked from being bundled can be straightened by pulling it between your thumb and forefinger.

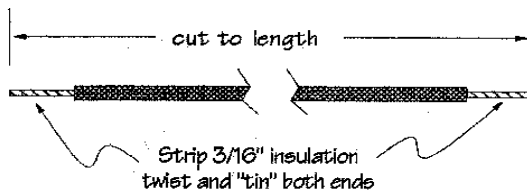

- ( ) Cut nine 2" long pieces from the length of #28 insulated stranded wire supplied and strip 3/16" of insulation from each end of each piece. Twist the exposed wire strands together and "tin" them by melting a small amount of solder into the strands. This will make soldering easier when the wires are installed and prevents fraying of the wire strands when they are pushed through the holes.

Solder one end of each of the wires prepared above to the connection points on the edge of the V/Hz Adapter Board. Trim off excess wire flush with the solder joints.

- |                               |                               |                              |                               |
|-------------------------------|-------------------------------|------------------------------|-------------------------------|
| <input type="checkbox"/> Out  | <input type="checkbox"/> In   | <input type="checkbox"/> "+" | <input type="checkbox"/> OctA |
| <input type="checkbox"/> OctB | <input type="checkbox"/> OctC | <input type="checkbox"/> G   | <input type="checkbox"/> SG   |
| <input type="checkbox"/> "-"  |                               |                              |                               |

Inspect your solder connections on the 9700-2 board carefully and smooth out any connections that need improvement as per the instructions on page 3.

- Use the four 4-40 X 1" Machine screws, four #4 X 3/4" aluminum standoffs and four 4-40 hex nuts to attach the V/Hz Adapter Board to the midi2cv8 board. Note the orientation of the two boards as shown in fig 3. This board will need to be moved out of the way when wiring to the midi2cv8 output and gate pads so do not fully tighten this hardware.

Connect the wires coming from the V/Hz board to the corresponding connection points on the midi2cv8 board. Trim excess.

- |                               |                               |                               |
|-------------------------------|-------------------------------|-------------------------------|
| <input type="checkbox"/> Out  | <input type="checkbox"/> In   | <input type="checkbox"/> "+"  |
| <input type="checkbox"/> OctA | <input type="checkbox"/> OctB | <input type="checkbox"/> OctC |
| <input type="checkbox"/> G    | <input type="checkbox"/> SG   | <input type="checkbox"/> "-"  |

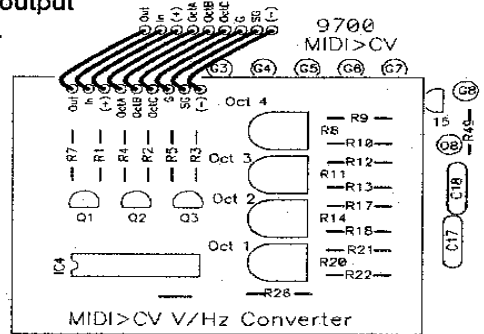

**This completes the electronic assembly and installation of the V/Hz Adapter.** If you will be using the midi2cv8 for retrofit or custom applications proceed to the Testing and Calibration section of this manual starting on page 19. If you will be using the Rack Mount Accessory Kit, follow the instructions in the manual which accompanied the 9700rck kit. Assembling the optional FracRak Accessory Kit begins below.

### 9700frm FracRak Accessory Kit Assembly

The 9700frm Accessory Kit adds power transformer, output jacks, Power Switch, Power-on LED and 2W Fractional Rack format panel to the midi2cv8 converter board.

Unpack the parts in the 9700frm parts bag and check them against the packing list on page 28 of this manual.

---

## "Flying" Wires

(i.e. those which go from circuit board to panel mounted parts.)

In the following steps, wires will be soldered to the 9700-1 board which in later steps will be connected to the Switch and Jacks on the front panel. Notice that three different kinds of wire are supplied, #22 insulated stranded (many small wire strands are twisted together), smaller diameter #24 solid insulated (only one "strand") and #22 bare wire (no insulation).

These first connections use the larger #22 stranded wire. At each step, cut a piece of wire to the specified length and strip 3/16" of insulation from each end. Twist the exposed wire strands together and "tin" them by melting a small amount of solder into the strands (see illustration on page 13). Solder each wire as it is installed and clip any excess off flush with the solder joint.

*If a V/Hz adapter board has been installed, remove its hardware and fold the 9700-2 board out of the way while the following wires are soldered in place.*

PC POINT	LENGTH	PC POINT	LENGTH
( ) "O1" (see fig 5)	6-1/2"	( ) "G1"	6-1/2"
( ) "O2"	6-1/2"	( ) "G2"	6-1/2"
( ) "O3"	6"	( ) "G3"	8"
( ) "O4"	6-1/2"	( ) "G4"	6-1/2"
( ) "O5"	7"	( ) "G5"	7"
( ) "O6"	7-1/2"	( ) "G6"	7-1/2"
( ) "O7"	8"	( ) "G7"	8"
( ) "O8"	8-1/2"	( ) "G8"	8-1/2"
( ) "SG"	8-1/2"		

The last two connections to be soldered to the board use the smaller diameter #24 solid insulated wire. In later steps, this smaller wire will make the multiple connections to the Power Switch's small solder lugs easier. Prepare both of these wires by stripping 3/16" of insulation from each end. Tin the end of the wire to make sure that it will accept solder easily when installed. As with previous connections, clip any excess wire off flush with the solder joint.

PC POINT	LENGTH	PC POINT	LENGTH
( ) "G"	8"	( ) "S"	9"

## Front Panel Parts

Now we will put the circuit board aside temporarily and mount the power switch and jacks on the front panel at the locations shown in fig 4.

- ( ) Using the hardware supplied with them, mount the eight 1/8" Stereo Phone Jacks on the panel. Note the recommended orientation with the sleeve ( "S" ) lug facing away from the nearest panel edge. Fully tighten the hardware.

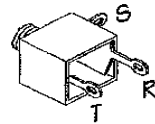

While the panel is relatively open and the sleeve ( "S" ) lugs of the jacks are accessible we'll use the length of bare wire supplied to run the common ground wire between all the jacks (see fig 5).

- ( ) Lift the "S" lugs of each of the jacks away from the panel and twist them slightly so that the bare wire can be passed through the holes in each of them in turn. Clip the excess off at each end. Solder the connections at J3-J9, but there will be another wire connect to J10 so **DO NOT SOLDER THE CONNECTION AT J10.**

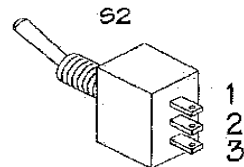

- ( ) Using the hardware supplied with it, mount the SPDT Power Switch, S2, in the location shown in fig 4. The switch is symmetrical, either end can be "up". Tighten the hardware.

The Power LED (D5) and it's associated current limiting resistor R38 wire directly to the solder lugs of S2 as shown in fig 5. Locate the LED and 4700 ohm resistor (yellow-violet-red). Cut the cathode lead of the LED (closest to the orienting flat on the case) and one lead of the resistor to a length of 1/2". Loosely twist these two leads together and solder as shown.

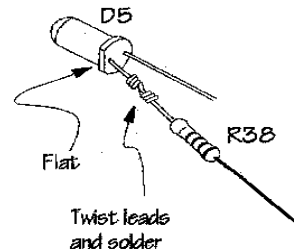

- ( ) Push the lens of LED D5 though the hole provided for it in the control panel as shown in fig 5. Connect the anode (free lead) of D5 to lug 1 of S2 by passing it through the hole in the lug. **DO NOT SOLDER THIS CONNECTION**, there will be more wires added to this point shortly.
- ( ) Connect the free end of R38 to lug 2 of S2 by forming a loop in the end of the lead and crimping it around the lug for a firm mechanical connection. **DO NOT SOLDER THIS CONNECTION.**



- ( ) Locate the Wall Mount Transformer (PWR1).

If this part has a connector on the end of it's cable, remove and discard it as shown.

Prepare the end of the cable by separating the two wires to a point about 1-1/2" back from the end. Strip 1/4" of insulation from each of the ends and twist and tin the exposed wire strands. Tie a knot in the cable 3" back from the end.

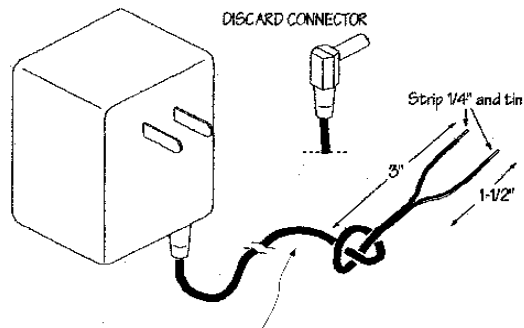

- ( ) Connect either of the leads from PWR1 to lug 3 of S2 by passing it through the hole in the lug. This is the only wire that will connect to this lug, **SOLDER THIS CONNECTION**. Clip off any excess wire flush with the joint.

Use the rubber grommet and install here, between the knot and the transformer, when building for an FR-7 as with the P9700S.

- ( ) Form a hook in the end of the remaining lead of PWR1 and attach it to lug 1 of S2 by crimping it around the lug for a good mechanical connection. There will be a third wire added shortly, **DO NOT SOLDER THIS CONNECTION**.

Now it's time to use the #4 hardware and "L" brackets to attach the front panel to the circuit board. Before beginning, take a good look at the "L" Brackets and note that one of the holes is threaded and the other is not.

If you have a V/Hz board installed it is best to leave it loose since you will need to check the origins of wires while wiring the panel, but if this seems too unwieldy you may temporarily reinstall the machine screws, stand-offs and nuts in two diagonal corners of the board.

- ( ) Attach the "L" brackets to the circuit board using two 4-40 X 1/4" Machine Screws through the board from the solder side and then through the **unthreaded** holes in the "L" brackets. Secure each with a #4 nut. Some adjustment will be required when the board is attached, so do not fully tighten the screws.
- ( ) Bend D2 over so that it engages the hole provided for it in the front panel as shown in fig 4. Attach the circuit board to the front panel by passing 4-40 X 1/4" Machine Screws through the panel from the front and into the **threaded** hole in the "L" brackets (see fig 4). When satisfied with the alignment of panel, LED and circuit board, fully tighten the hardware.

We're now ready to finish assembly by connecting the wires from the circuit board to the jacks and switch on the front panel. In the following steps individual solder lugs are identified by part number and lug number. For example, S2-2 means the lug labeled "2" of the Power Switch S2. Each step includes an instruction such as (s2), which means that the connection should be soldered and at that point there will be two wires on the lug in question. If there are not the number of wires specified at the lug when you get ready to solder, recheck to see what has gone wrong.

Be careful when soldering the wires to the power switch. Too much heat can soften the body of the switch causing the solder lugs to shift position. If you are using a 30W or less soldering iron there is little danger, but higher power irons should not be left on the lugs too long. For ease of access while soldering, proceed from left to right as you would read a page.

FROM	TO	FROM	TO
( ) "S"	S2-2 (s2)	( ) "G"	S2-1 (s3)
( ) "G1"	J3-R (s1)	( ) "O1"	J3-T (s1)
( ) "G2"	J4-R (s1)	( ) "O2"	J4-T (s1)
( ) "G3"	J5-R (s1)	( ) "O3"	J5-T (s1)
( ) "G4"	J6-R (s1)	( ) "O4"	J6-T (s1)
( ) "G5"	J7-R (s1)	( ) "O5"	J7-T (s1)
( ) "G6"	J8-R (s1)	( ) "O6"	J8-T (s1)
( ) "G7"	J9-R (s1)	( ) "O7"	J9-T (s1)
( ) "G8"	J10-R (s1)	( ) "O8"	J10-T (s1)
( ) "SG"	J10-S (s2)		

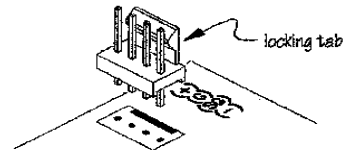

If you will be using the 9700 to power other modules, install the header from the power connector set as shown.

- ( ) Gather the wires from the circuit board to the front panel controls together and cinch the bundle with the two Nylon Wire Ties supplied as shown. Cinch the wire ties tight and clip off the excess.

If you have installed the 9700vHz V/Hz Adapter, permanently reinstall it using the stand-offs, screws and nuts. Tighten all hardware.

- ( ) Use the last Nylon Wire Tie to provide strain relief for the Power Transformer cable by passing the tie through the hole in the top edge of the circuit board and around the cable behind the knot as shown in fig 4. Cinch the wire tie tight and clip off the excess.

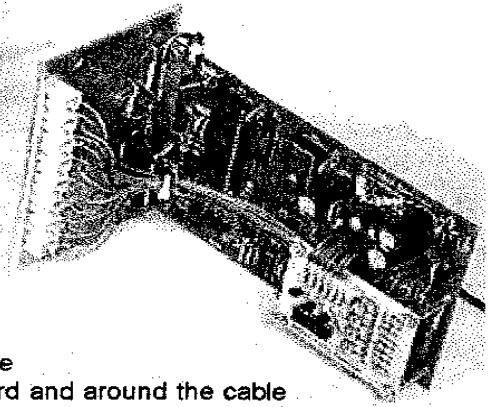

**This completes assembly of the midi2cv8 and FracRak Accessory Kit.**

## Testing and Calibration

Admire your work a little, then take a break and think about something else for a while. When you come back, recheck your work completely again. Be critical. Are all the parts in the right place and pointing the right way? Are the solder joints smooth and shiny? If not, reheating will probably help. If there are blobs of solder on the board they can be removed by holding the board upside down and flowing the excess solder off onto the clean tip of a hot soldering iron.

Take your time, a problem spotted now can save a lot of frustration later.

After rechecking your work, it's time for the all important smoke test. If anything unfortunate is going to happen, this is the most likely time. If you have 9700frm or 9700rck accessory kits power is supplied by the Wall Mount Transformer PWR1, which should be plugged into a live 110VAC outlet. See the custom applications section on pg 24 for details of applying power in custom situations. Toggle the Power switch to "ON". The Power LED (D5) should light and if it doesn't you should immediately unplug the unit from the wall and find out why. The problem could be nothing more than a dead wall outlet. Improperly placed components or solder bridges on the circuit board may be the cause. Check the orientation of the Integrated Circuits, Diodes and Electrolytic Capacitors.

When the Power LED lights. Let the unit idle for a few minutes while you check for parts that may be getting hot or any unusual smells, smoke, etc. Two components will get quite warm during normal operation, the voltage regulator IC14 and the two 1W resistors that form R50. If any other parts get too hot to touch, turn off power and find out why.

The first test you run should be the Self-Test beginning on the following page. You will need some way to monitor the midi2cv8's outputs, such as a Volt-Ohmmeter or oscilloscope. A Synth's VCO makes a convenient tester. The stepped and ramp Control Voltages produced sequentially at the outputs will be easily recognizable as a wide pitch sweep.

If no other tester is available you can make your own out of an LED and current limiting resistor as shown in the diagram. Building the tester on a 1/8" stereo phone plug allows it to be plugged into each output in turn. The LED glows more brightly as voltage increases and even changes of a fraction of a volt produce discernible brightness changes. Notice that both the CV and the associated trigger transistor are tested at the same time since the transistor has to turn on in order for there to be a return path for the LED current (see the schematic, fig 7). If the tester shows no activity on a given output, there may be problems either with the output's S/H buffer amp, e.g. IC11:A, or the trigger transistor associated with it (Q8). To test only the CV output, return the cathode of the diode to the Gnd lug (Sleeve) of the plug instead of the Ring.

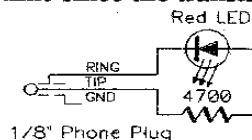

While it is convenient that the LED tester verifies both the CV output and it's associated trigger transistor, it is the CV (the voltage on the Tip of the connector referenced to the ground Sleeve) that you will be measuring if you're using test equipment or a VCO to verify operation. The Trigger output will not be active unless a pull-up resistor or current source is connected to the open collector of the transistor.

Before proceeding with the Self-Test use a narrow bladed screwdriver or knife blade to center the adjusting disks of all trimmer potentiometers; R29 on the midi2cv8 board and R8, R11, R14 and R20 on the V/Hz Adapter.

## SELF-TEST

The Self-Test consists of two sections; an Output Test that allows a check of how individual outputs are functioning and a MIDI-In Test which verifies that MIDI data is being properly received by the processor and that Basic Channel, as set by the System default DIP, is being recognized.

The Output Test proceeds in two sections. In the first section each output is "strobed" in turn by turning it fully on (10V) for about 1/2 second before turning it back off and stepping to turn on the next. The second part of the test sequentially ramps each output from minimum to maximum, taking about 3 seconds to go from 0V to 10V. At the end of this cycle all outputs will be high but the test loops with the result shown in the illustration in the firm-ware operation supplement.

Start the test with no MIDI In connected. Set the system default DIP as shown and turn the unit off and back on (mode changes are only recognized as part of the reset sequence). While monitoring any given output you will see a voltage that first briefly jumps up to 10V and then returns to zero. After a few seconds the output will take three seconds to ramp up to about 10V and hold there for several seconds before returning to zero again.

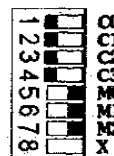

Self-Test

If the outputs don't behave as they should there could be many things wrong, from a non-functioning (possibly shorted) power supply line to a popped uC chip or backward diode. Take a good look at the board and if you are not able to find any soldering or parts placement problems, proceed to the next test anyway, since it will help localize the problem.

Temporarily deselect Self-Test mode by toggling system default switch M0 to "on" and turning the midi2cv8 off and on again to reset. Plug a MIDI source such as a keyboard or computer into the midi2cv8 MIDI-In Jack (J1) and turn it on. First observe that MIDI data

---

coming in to the midi2cv8 causes the MIDI Activity LED (D5) to blink very briefly, you will have to watch it carefully if only single notes or program changes are the data. Pitch wheel data will cause the LED to glow a little brighter because it is continuous activity. If you see no indication of data being received, and are sure that data is being sent, it is indicative of problems in the MIDI In and Thru circuitry around IC5 and IC6. If you don't see anything wrong, try removing the uC, IC3. If D2 now winks in response to MIDI data it's an indication that the uC is bad.

When you can see that MIDI data is being received, switch back to Self Test to make sure it is being recognized. The MIDI-In test looks at the MIDI byte received and blinks the MIDI Activity LED brightly to indicate that it data was recognized and the kind of byte it was. Set the system DIP switch as shown and turn the midi2cv8 off and then on again.

Since most MIDI sources send on channel 1 by default, this is the channel selected in the illustration. Settings for other channels are summarized on page 24. Send in data (press a note or select a program change or run the pitch wheel up and down) and observe that the MIDI Activity LED responds by blinking very brightly and continuously, even when MIDI data stops. If the LED does not behave this way check the soldering on pin 10 of the uC (IC3).

Note that the blinking pattern of the LED tells what kind of byte was received, as detailed in the firmware supplement. Assuming the midi2cv8 and controller are set to the same Basic Channel, the LED should be blinking in the "Status Byte on Basic Channel" pattern. If the LED indicates that a MIDI Data byte was received instead, it probably means that the controller is sending Running Status data and the midi2cv8 has been reset since the last Status Byte. Reset both the MIDI source to be sure a Status Byte is sent and the midi2cv8 to run Self-Test again. If the LED pattern is "Status Byte NOT on Basic Channel", and you are confident that both the midi2cv8 and controller are set to the same channel, take a close look at the circuit board around the System Default DIP and it's connections to the uC.

## **Interpreting Results**

If both the tests worked OK, there's really only one interpretation, you have a properly working midi2cv8 and you can skip to the Tuning and Applications sections on the following page.

If neither the Self-Test nor the MIDI-In tests passed, It's likely that the uC is not running the firmware for some reason. Perhaps the chip itself is bad, though this is statistically the least likely cause. More likely is that there is a misplaced part or bad connection somewhere in the digital part of the circuitry. Focus your attention on the uC (IC3), the PROM (IC2) and it's address latch (IC1).

---

If either one of the two tests passed, you can be sure that the uC and the other components mentioned above are functional and happily running the firmware.

If only the Self-Test failed, but MIDI-In was OK, there is a problem in the analog portion of the circuitry. If none of the outputs show any response, look closely at the parts that are common to all the outputs, specifically the DAC (IC8) and it's data latch (IC7) and the DAC's current to voltage converter IC10:B. The MUX (IC13) might be the problem, but this is less likely.

If some of the outputs functioned during the Self Test and other were nonresponsive, try to find some pattern to the failure and focus your attention on the parts in common to those outputs. For example, if only outputs 1-4 are dead, notice that the S/H buffers for these outputs are all in IC11, which makes that part suspect. If alternating outputs are dead it may mean that one of the bits that causes the MUX (IC13) to select different outputs is frozen high or low by a bad solder joint, solder bridge or bad level shifting transistor Q4-Q7.

## Tuning

When you're confident that the midi2cv8 is working, it's calibration time. The procedures that we'll use can be done by ear, since they only involve making adjustments to produce pitches from a VCO that are in unison with the pitch of a reference instrument. Alternate tuning procedures using fixed pitch references and other equipment are given in the illustrations supplement. Any tuning will begin by plugging a MIDI source, such as keyboard or sequencer, into the midi2cv8's MIDI-IN jack J1 and verifying that MIDI data is being received.

Calibration of any output calibrates all outputs so any mode that produces a pitch output on any of the channels can be used. In most cases mode 1 will be the best choice and the pitch CV from output 1 will connect to the pitch CV input of a Voltage Controlled Oscillator. Connect the VCO's audio output to an amplifier so it can be heard. Tuning will be easiest if you monitor the VCO output directly during tuning, without running it through VCA's, VCF's or other processing elements. If you have a choice of waveforms, a triangle is good for discerning pitch differences.

If you are using a keyboard with sound generators, the pitches produced by the instrument itself can be used as the reference and calibration will be performed by tuning for unison between the VCO's output and the reference. Through a mixer or "Y" connector, send the keyboard's audio output to the amplifier so that it and the VCO can be heard at the same time. Even if you will be tuning for V/Hz tempering you should scan the following V/oct procedure before you actually tune following the instructions on the facing page. Similarly, if there are any confusing points in the V/oct procedure they may be clarified by reading through the V/Hz one.

---

**V/Oct Tuning** When tempered to V/oct, the midi2cv8 responds to all note messages from 0 to 127. This tuning is fairly simple because the only adjustment on the midi2cv8 board is R29, the DAC Tune trimmer. You will get somewhat better accuracy if you tune over the widest range possible. If your keyboard is capable of 5 octaves, tune to notes the full five octaves apart. If only a three or four octave controller is available, this will work fine, tune between the lowest and highest notes available.

Proceed as follows: Press the lowest note on the keyboard and adjust the Pitch control of the VCO for unison with the pitch of the reference (note that this first adjustment is of the VCO, not the midi2cv8). Next, press the highest note on the keyboard and this time adjust R29 on the midi2cv8 board so that the VCO and reference are in unison.

Once again press the lowest note and adjust the VCO pitch for unison, then the highest note while R29 is adjusted for unison.

After you have gone back and forth between adjusting oscillator pitch while pressing the lowest note and R29 while pressing the highest note a few times you will find that both pitches are in unison with no further adjustments. This completes calibration of the midi2cv8.

**V/Hz Tuning** When tempered for V/Hz, the midi2cv8 responds to MIDI notes in the range of 36 - 150 (24h to 96h). Note messages outside this range are ignored. The initial part of the calibration will be very similar to the tuning in V/oct procedure with one major exception: Not just any interval can be used. You must calibrate between MIDI note 24h, which we'll call C0 - the lowest C on any keyboards or controllers that we know of, and the C one octave higher (C1). Other intervals cannot be used during initial tuning because their outputs depend on the settings of trimmers on the 9700vHz board that will not be calibrated until later. See the V/Hz design analysis section on pg 27 for more details.

Proceed with calibration by pressing C0 and adjusting the pitch control of the VCO for unison with the reference. Next press C1 and adjust R29 on the midi2cv8 for unison with the reference. Go back and forth between C0, adjusting oscillator Pitch, and C1 while adjusting R29 until no further changes are necessary.

Once the DAC is tuned, the trimmers that set octave intervals (R8, R11, R14 and R20) are adjusted so that the pitch changes by octaves as you go down the keyboard by octaves. Press C4 and adjust R8 for unison, then C3 while adjusting R11, C2 while adjusting R14 and C1 while adjusting R20. These adjustments do not interact between themselves or with the tuning of the DAC, so you usually only have to go through them once for them to be right, and the circuitry is simple and stable so they tend to stay right for a long time.

## System Default Switch

The DIP Switch S1 sets Basic Channel and Operating Mode as shown in the charts below. Detailed explanations of operating modes can be found in the illustration supplement. Note that the eighth switch section is a spare and is not used in setting channel or mode.

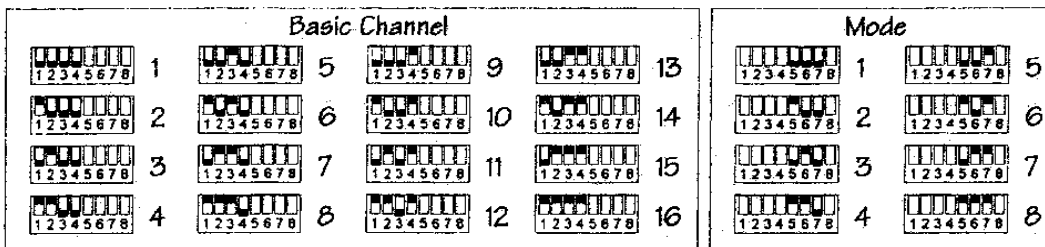
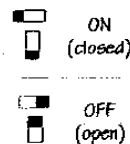

## Custom Apps

By definition, custom applications are unique so it is difficult to give details of any specific one. Over time, some will prove to be more popular than others and you should check the World Wide Web at [www.paia.com/midi2cv.htm](http://www.paia.com/midi2cv.htm) for details on the most popular of them. Here are some general pointers to get you started-

**POWER** There are several different options for powering a midi2cv8 board. Probably the simplest is to apply 12VAC, from an existing transformer in a piece of gear, perhaps, to points "S" and "G" on the circuit board. The transformer should have about 3.5 Watts of reserve capacity (about 300 mA at 12 VAC).

DC power from an existing power supply can be connected to the "+", "G" and "-" pads in the upper right hand corner of the circuit board. Any voltage from about 12V to 18V will be OK. Current drawn from the "-" supply line will be a nearly negligible 5 mA or less, but the current required from the "+" will be a hefty 200 mA or so. Be sure that the existing supply has this kind of current reserve on it's "V+" line.

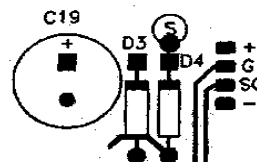

**GROUNDING** When working the midi2cv8 into a custom or retrofit application, connect the "SG" pad in the upper right hand corner of the midi2cv8 board to the star ground point in the equipment being retrofitted. If you are drawing power from an existing transformer no other ground is necessary. If you are tapping DC power, also run a separate line from the "G" pad in the aux power group to the star ground point.



**Pitch Wheel** voltages must be greatly attenuated before using them for pitch bend. Without attenuation each increment represents a semi-tone. This produces the neat effect of allowing the pitch wheel to be played like a quantized theremin, but it's not what most people have in mind for pitch wheels. The attenuation network shown in the illustration will scale pitch wheel voltages to a more usable one or two semitone total range. In the process, the quantization steps are also attenuated to about 1.5 cents each - below the generally accepted limen of perception of 3 cents. In other words, no zipper.

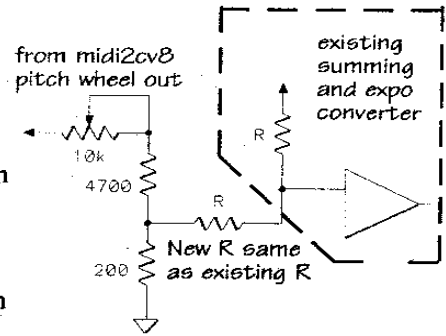

**"S" Triggers** - While many synths and other devices are triggered when a Gate signal goes from ground to some voltage the designer liked (5 and 10V are common), MOOG Synths and some others employ "S" Triggers. (S)witch Triggers are also called "wired-or" because switches or transistors can be logically "OR'd" together simply by adding more of them. In the illustration, any of the keyboard switches being closed pulls the "S" Trigger line low. In techno-speak this is often called a "switch closure to ground" for fairly obvious reasons.

Gate signals are often changed into "S" Triggers by using them to turn on a transistor which then pulls the "S" Trigger line to ground. On the midi2cv8 these transistors are already in place, simply connect the appropriate "G" pad to the "S" trigger input. Gate outputs on the "O" pads can be used simultaneously with the "S" trigger outputs.

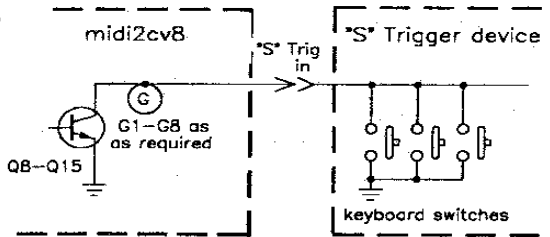

**DIN-Sync** outputs can be connected to the MIDI Thru jack (J2) using three lengths of stranded insulated wire on the bottom of the circuit board as shown in the illustration. Notice the ground connection from pin 7 of IC6 to pin 2 (the middle pin) of J2. It should not be necessary to disable the MIDI on this jack since there are no pin conflicts between these two standards.

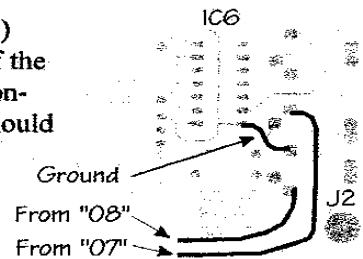

## Design Analysis

As shown in the schematic, fig 7, the midi2cv8's brain is an 8031 MicroController (IC3). Firmware for the system is burned into the EPROM (IC2) which is attached to the uC's address and data lines with the Octal Latch IC1. The DIP switch S1 connects to seven of the uC's input port lines. Four of the switches in this package are used to select MIDI Channel, three select mode and the eighth is unused.

---

The receive (RxD) line of IC3 receives MIDI Data from the mandatory optocoupler IC5 which isolates the ground of the MIDI sending device from the midi2cv8 ground. The output of the optocoupler is also buffered by a pair of Inverter stages (IC6:B & A) which drive the MIDI Thru output J2. A third Inverter stage, IC6:C, drives the LED D2 to give an indication of MIDI activity on the input J1.

A single 8-bit Digital to Analog Converter (IC8) is time-division multiplexed into eight Control Voltage outputs. The DAC itself is connected to the uC.databus by octal latch IC7 which is triggered by IC3's /WR line anytime a write to external memory instruction is executed. Since no address lines are used to select the DAC it is effectively mapped into the entire external RAM space of the uC. The reference current into the DAC is set by R31 and the Tune trimmer R29 which connect to the regulated 5V supply. The output current of the DAC is converted to a voltage by IC10:B.

DeMultiplexing of the output is accomplished by the 4051 type 1 of 8 analog switch IC13. Note the use of level shifting transistors Q4 - Q7 which translate the 5V outputs of the uC into signals that go all the way to the V+ supply rail to switch IC13 so that it can work with the 10V maximum Control Voltage signal level. Three lines from the uC port 3 are used to address the mux to select one of 8 S/H amplifiers built from IC11 and IC12. The fourth line acts as a strobe that allows the MUX to be "turned on" after the value to be output has been sent to the DAC. Taking the first output as typical, the MUX charges C10 by connecting it to the DAC and IC11:A is wired as a high impedance voltage follower that buffers the voltage on the capacitor so that it can hold a charge while the other outputs are being refreshed. The open-collector transistor (Q8) at the output of the S/H is useful when the output is used as a trigger or switch control output.

In operation, the firmware for the uC causes it to constantly be going through a sequence of refreshing all eight of the outputs. From an internal table of values to be output it pulls the value to be output and puts it to the DAC. After a short time delay to allow the new value to stabilize, the MUX is strobed to connect it to the S/H selected by the lower three control lines. After a delay to allow the S/H capacitor to once again charge to the correct voltage the MUX's INH line is raised to isolate the S/H. Following a brief delay the cycle repeats, the DAC is set up for the value of the next output and the address of that output is sent to the MUX, allowed to settle briefly and the MUX then turned on to update the next S/H.

Analysis of the firmware is beyond the scope of this hardware design analysis, but an extensively commented copy of the source code can be found on the World Wide Web at [www.paia.com/midi2cod.zip](http://www.paia.com/midi2cod.zip).

Power is typically supplied to the midi2cv8 board with a 12VAC secondary transformer as shown. The AC from the transformer is half-wave rectified by D3 for a positive supply line and D4 for a negative supply line. C19-C22 and R51 and R52 provide filtering for these

and D4 for a negative supply line. C19-C22 and R51 and R52 provide filtering for these voltages but notice that there will be a significant amount of ripple voltage on them, which is OK because they are not used for reference. Ripple free, regulated 5V for the uC is provided by the Dropping resistor R50 and the 7805 Voltage Regulator IC14 and this voltage is coupled by R29 and R31 and filtered by C8 and used for the reference for the DAC.

## V/Hz Design Analysis

When the midi2cv8 is scaled for V/Hz, the DAC generates only a single octave of Control Voltages. Whole octave changes are produced by the addressable voltage divider shown in fig 6 - remember that in V/Hz scalings dividing the control voltage in half lowers the pitch an octave.

So that the full range of the DAC can be used for maximum resolution, it actually generates only the part of the CV that *changes* within the octave. In the midi2cv8 the highest octave of voltages range from 5V up to 10V. While the DAC produces a CV from 0 to 5V, there is also a 5V offset - produced when the regulated 5V supply line is inverted by IC10:A and R39 and R40 - which is summed into the current to voltage converter IC10:B by #R32 (see fig 7). As the DAC is driven full scale with data from 00h to ffh the output of IC10:B goes from 5V to 10V.

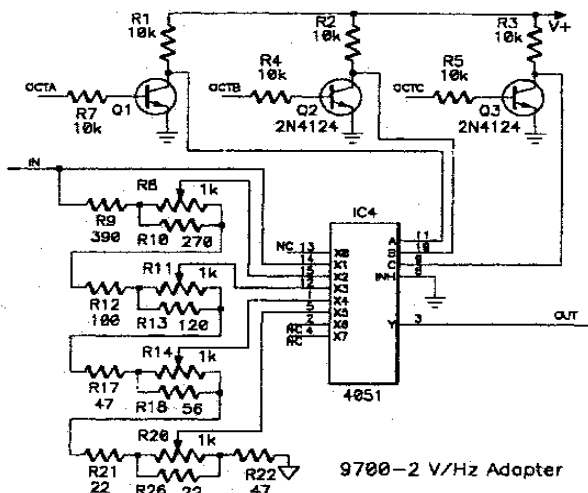

Fig 6. The V/Hz Adapter circuit is a voltage divider with taps at octave ratios of 1, 1/2, 1/4, 1/8 and 1/16

For all but the lowest octave the DAC is not used to cover the whole 13 pitches, only the 12 from C to the C# below it. The final step, from C# to the C a single semitone down, is generated not by sending 00h data, but by stepping the DAC back to full scale and selecting the lower octave with the addressable divider.

In the lowest octave the lowest C is produced by sending 00h to the DAC without octave switching. This is why the converter is initially calibrated in the lowest octave, where the DAC Tune trimmer R29 is set so that the max output exactly matches offset supplied by #R32.

## midi2cv8 Parts List

<i>Semiconductors</i>		
1	27c64 PROM W/Firmware	IC2
1	4051 1/8 Mux Demux	IC13
1	6N138 Opto Coupler	IC5
1	74HC14 Hex Inverter	IC6
2	74HC373 8 Bit Latch	IC1,IC7
1	7805 +5V Voltage Regulator	IC14
1	80c31 uController	IC3
1	DAC08 8 Bit DAC	IC8
1	LM324 Quad OpAmp	IC10
2	TL084 Quad OpAmp	IC11,IC12
1	1N914 / 4148 Signal Diode	D1
1	Red LED	D2
2	1N400x Power Diodes	D3,D4
12	2N4124 NPN Silicon Transistor	Q4-Q15
<i>Ceramic Disk Capacitors</i>		
1	0.005 <small>0.0047 (472)</small>	C24
4	0.01	C4,C5,C6,C7
2	33pF	C2,C3
<i>Mylar Capacitors</i>		
8	0.1	C10-14,C16-C18
<i>Electrolytic Capacitors</i>		
2	10uF	C1,C15
1	2.2uF	C8
2	220uF / 16V	C20,C22
2	2200uF / 25V	C19,C21
1	470uF / 25V (see pg 6)	C23
<i>PC Mount Trimmer Potentiometers</i>		
1	1k	R29
<i>All resistors 1/4W, 5%</i>		
1	100 brown-black-brown	R52
1	1000 brown-black-red	R41
5	10k brown-black-orange	R23-R25,R27,R53
4	100k brown-black-yellow	R34-R37
1	2200 red-red-red	R31
3	220 red-red-brown	R16,R30,R33
1	330 orange-orange-brown	R15
3	2700 red-violet-red	R19,*R28,#R32
10	33k orange-orange-orange	R39,R40,R42-R49
1	47 yellow-violet-black	R51
3	4700 yellow-violet-red	R6,R28,R54
1	5600 green-blue-red	*R28
<i>Miscellaneous</i>		
2	15 ohm 1W	R50
2	5 Pin DIN Connector (pc mount)	J1,J2
1	8 Position DIP Switch (piano style)	S1
1	12mHz Crystal	X1
1	28 pin DIP Socket	
1	40 pin DIP Socket	
1	9700-1 Circuit Board	

## 9700vHz V/Hz Conversion Board

1	4051 1/8 Mux Demux	IC4
4	1k Trimmer pots	R8,R11, R14,R20
3	2N4124 NPN Silicon Transistor	Q1,Q2,Q3
1/4 W 5% resistors		
6	10k brown-black-orange	R1-R5,R7
1	390 orange-white-brown	R9
1	270 red-violet-brown	R10
1	100 brown-black-brown	R12
1	120 brown-red-brown	R13
2	47 yellow-violet-black	R17,R22
1	56 green-blue-black	R18
2	22 red-red-black	R21,R26
1 9700-2 Circuit Board		
1 20" Length #28 (small) Stranded Wire		
4 #4-40 X 1" Machine Screw		
4 #4 X3/4" Rolled Aluminum Stand-offs		
4 #4 Machine nuts		

## FracRak Accessory Kit

8	1/8" Stereo Phone Jacks	J3-J10
1	12VAC Transformer	PWR1
1	SPDT Toggle Switch	S2
1	Red LED	D5
1/4W 5% resistor		
1	4700 yellow-violet-red	R38
2	#4 "L" Brackets	
2	4-40 Machine Nuts	
4	4-40 X 1/4" Machine Screws	
4	#4 x 3/8" Self Tap Screws	
3	Nylon Wire Ties	
1	MIDI2CV8 panel	
2	66" lengths #22 Stranded Insulated Wire	
1	20" length #24 Solid Insulated Wire	
1	4" length #22 Bare Wire	

Bookmark [www.paia.com/midi2cv.htm](http://www.paia.com/midi2cv.htm)

\*R28 = 2.7k with V/Hz option  
5.6k without option  
#R32= only used with V/Hz option

